

A PROGRAM OF IBHS

# FORTIFIED

HOME

TM

2020

# STANDARD

WEATHER HAZARDS



Hurricane



High Wind



Hail

LEVELS



This page intentionally left blank

## Table of Contents

<b>1 Program Overview.....</b>	<b>4</b>
1.1 Designations .....	4
1.2 Designation Term Limit and Re-Designations.....	7
1.3 Scope of FORTIFIED Requirements.....	7
<b>2 Eligibility and Minimum Requirements for all Designations .....</b>	<b>8</b>
2.1 Applicable Regions .....	8
2.2 Qualifying Dwelling Types.....	9
2.3 Ineligible Foundation Types .....	10
2.4 Qualifying Foundation Types .....	11
2.5 Qualifying Roof Structural Members .....	13
2.6 Qualifying Ring-Shank Nails .....	13
2.7 Acceptable Debris Impact Ratings for Openings and Opening Covers.....	14
2.8 Acceptable Design Pressure (DP) Ratings .....	14
2.8.1 Acceptable Design Pressure (DP) Ratings for Roof Covers.....	14
2.8.2 Acceptable Design Pressure (DP) Ratings for Openings .....	15
2.9 Referenced Codes and Standards.....	15
2.10 Ultimate vs. Nominal Wind Speed ( $V_{ult}$ vs. $V_{asd}$ ) .....	16
2.11 Corrosion Protection Requirements for Fasteners and Connectors in Coastal Regions	17
2.12 Documentation Requirements .....	18
2.13 Recommendations for Flood Mitigation.....	19
2.14 Appropriate Use of FORTIFIED .....	19
<b>3 Designation Requirements for FORTIFIED Roof – Existing Roof .....</b>	<b>20</b>
3.1 Roof Deck and Roof Cover .....	20
3.2 Sealing and Strengthening of Roof Deck .....	21
3.3 Attic Vents and Covers (Hurricane Designation Only) .....	24
3.4 Photovoltaic (PV) Systems .....	25
<b>4 Designation Requirements for FORTIFIED Roof – New Roof.....</b>	<b>26</b>
4.1 Roof Deck Minimum Thickness Requirements .....	26
4.2 Attachment of New Roof Deck Only.....	28
4.2.1 Attachment of Wood Board Roof Sheathing .....	28
4.2.2 Attachment of Wood Structural Panel Roof Sheathing (Plywood or OSB) .....	28
4.3 Inspection and Attachment of Existing Roof Deck (Re-Roof) Only .....	31
4.4 Sealing the Roof Deck (roof slopes 2:12 or greater) .....	33
4.4.1 Sealing the Roof Deck for Shingle and Metal Roof Covers .....	33
4.4.2 Sealing the Roof Deck for Concrete and Clay Tile Roof Covers .....	39
4.5 Drip Edge (roof slopes 2:12 or greater).....	42
4.6 Flashing .....	44
4.7 Steep-Slope (2:12 and greater) Roof Coverings Only.....	45
4.7.1 For Asphalt Shingles Only (Steep Slope):.....	46
4.7.2 For Clay and Concrete Tile Only (Steep Slope).....	49
4.7.3 For Metal Shingles and Panels Only (Steep Slope) .....	50
4.7.4 For Other Steep-Slope Roof Coverings .....	50

4.8	Low-Slope (less than 2:12) Roof Coverings Only .....	51
4.9	Attic Vents and Covers (Hurricane Designation Only) .....	52
4.10	Photovoltaic (PV) Systems .....	53
<b>5</b>	<b>Designation Requirements for FORTIFIED Silver.....</b>	<b>54</b>
5.1	Prerequisite Designation.....	54
5.2	Windows and Skylights (Hurricane Designation Only).....	54
5.3	Entry Doors (Hurricane Designation Only).....	55
5.4	Garage Doors .....	55
5.4.1	Garage Doors (Hurricane Designation Only) .....	55
5.4.2	Garage Doors (High Wind Designation Only) .....	56
5.5	Gable Ends .....	57
5.5.1	Gable End Wall Sheathing.....	57
5.5.2	Gable End Wall Framing and Bracing.....	58
5.5.3	Gable End Overhang Construction (Hurricane Designation Only).....	59
5.5.4	Vented Gable End Rake Soffits (Hurricane Designation Only).....	61
5.6	Soffits (Hurricane Designation Only).....	62
5.7	Chimneys.....	63
5.8	Attached Structures .....	64
<b>6</b>	<b>Designation Requirements for FORTIFIED Gold .....</b>	<b>66</b>
6.1	Prerequisite Designations .....	66
6.2	Wind Pressure Resistance of Windows and Doors (Hurricane Designation Only).....	66
6.3	Wall Impact Resistance (Hurricane Designation Only) .....	66
6.4	Continuous Load Path (CLP) Options for New Homes .....	67
6.4.1	Custom Engineered CLP Design by Professional Engineer.....	67
6.4.2	Prescriptive CLP Design for Wood Framing by Design Professional (High Wind Designations Only) 69	
6.4.3	Prescriptive CLP Design by Professional Engineer.....	69
6.5	Continuous Load Path for Retrofit of Existing Homes .....	70
<b>7</b>	<b>Designation Requirements for FORTIFIED Hail Supplement Only .....</b>	<b>71</b>
7.1	Applying Hail Requirements in Conjunction with Wind Requirements .....	71
7.2	Steep-Slope Roof Coverings Only .....	71
7.2.1	Asphalt Shingles.....	71
7.2.2	Clay and Concrete Roof Tiles.....	72
7.2.3	Metal Panels.....	72
7.2.4	Other Roof Coverings.....	72
7.3	Low-Slope Roof Coverings Only .....	72
7.4	Skylights .....	73
7.5	Photovoltaic (PV) Systems .....	73
<b>8</b>	<b>Appendices.....</b>	<b>74</b>
	Appendix A. FORTIFIED Home™ Standard Details.....	75
	Appendix B. Design Information .....	102
	Appendix B1. Roof Sheathing Attachment Requirements Outside of FORTIFIED Prescriptive Parameters.....	102
	Appendix B2. FORTIFIED Minimum Pressure Requirement Tables .....	102



Appendix C. References.....105  
Appendix D. Definitions .....106  
Appendix E. IBHS Roof Shingle Hail Impact Ratings .....110  
Appendix F. FORTIFIED Prescriptive CLP Design Limitations and Minimum Requirements  
for High Wind.....111  
Appendix G. FORTIFIED CLP Guidance for Retrofit of Existing Homes .....117

# 1 Program Overview

## 1.1 Designations

The FORTIFIED Home™ program was developed to reduce avoidable suffering and financial loss caused by hurricanes, high winds, and hail. The program requirements provide a systems-based, multi-tiered approach for improving the resistance of homes and their contents to damage caused by wind, wind-driven rain, and hail.

Achieving a “designation” means a home meets all requirements of a level of the FORTIFIED Home Program, required documentation of materials and installation has been submitted by an authorized third party and reviewed by IBHS, and a certificate of compliance for the property has been issued by IBHS.

### Available Designations

There are 24 available designations. Each is a combination of the designation level, applicable weather hazard, and roof category.

STANDARDS	DESIGNATION LEVELS					
	FORTIFIED Roof™		FORTIFIED Silver™		FORTIFIED Gold™	
	NEW ROOF	EXISTING ROOF	NEW ROOF	EXISTING ROOF	NEW ROOF	EXISTING ROOF
FORTIFIED Home™–Hurricane						
FORTIFIED Home™–High Wind						
<b>+ HAIL SUPPLEMENT</b>						
FORTIFIED Home™–Hurricane & Hail						
FORTIFIED Home™–High Wind & Hail						

## ***Designation Levels***

There are three designation levels—FORTIFIED Roof™, FORTIFIED Silver™, and FORTIFIED Gold™—that build on each other and address different systems of the home. FORTIFIED Roof is the first level. To attain FORTIFIED Silver (the second level), the FORTIFIED Roof designation requirements must first be met. To attain FORTIFIED Gold (the third level), both the FORTIFIED Roof and FORTIFIED Silver designation requirements must first be met.

## ***Weather Hazard***

The location of the home will determine which standard must be followed (FORTIFIED Home™–Hurricane or FORTIFIED Home™–High Wind). The optional FORTIFIED Home™–Hail Supplement may be used in conjunction with either standard (if all requirements are met) and will result in a FORTIFIED Home™–Hurricane & Hail or FORTIFIED Home™–High Wind & Hail designation.

## ***Roof Category***

Whether the roof is new or existing will also determine which program requirements must be followed.

- New Roof*** designations are only appropriate for new construction or re-roofing projects where all roof sheathing, sealed roof deck, and roof covering systems are newly installed (less than 5 years old) and installation in compliance with FORTIFIED Home requirements is verifiable at the time of designation.
- Existing Roof*** designations are appropriate for existing homes that have a roof and roof covering with greater than 5 useful years of life remaining that do not show visible signs of damage or deterioration. FORTIFIED homes seeking re-designation without re-roofing are only eligible for an Existing Roof designation. Similarly, newly installed roofs where the roof sheathing, sealed roof deck, and/or roof cover installation or wind rating cannot be verified are only eligible for an Existing Roof designation.

If a home qualifies for a FORTIFIED Roof – Existing Roof designation, then any higher-level designation (FORTIFIED Silver or FORTIFIED Gold) will also be indicated as “Existing Roof.” If the home qualifies for a FORTIFIED Roof – New Roof designation, then any higher-level designation (FORTIFIED Silver or FORTIFIED Gold) will also be indicated as “New Roof.”

**Goals of Each Designation Level**

	<p><b>FORTIFIED Home™–Hurricane</b> Build or retrofit home to minimize roof damage, attic water intrusion and associated damage by providing prescriptive roof sheathing and attachment, sealed roof deck, code-compliant roof covering, and approved roof and gable end vents/covers.</p>
	<p><b>FORTIFIED Home™–High Wind</b> Build or retrofit home to minimize roof damage, attic water intrusion and associated damage by providing prescriptive roof sheathing and attachment, sealed roof deck, and code-compliant roof covering.</p>
	<p><b>FORTIFIED Home™–Hurricane</b> Build or retrofit home to meet all requirements of FORTIFIED Roof + minimize damage from failure of windows and doors, garage doors, gable ends, chimney tie-downs, soffits, and attached structures such as porches and carports.</p> <p><b>FORTIFIED Home™–High Wind</b> Build or retrofit home to meet all requirements of FORTIFIED Roof + minimize damage from failure of garage doors, gable ends, chimney tie-downs, and attached structures such as porches and carports.</p>
<p><b>(Optional) Additional Requirements</b></p>	<p><b>FORTIFIED Home™–Hail Supplement</b> Build or retrofit roof to minimize impact damage due to hail by providing properly impact-rated roof covering, skylights, and PV systems.</p>



## 1.2 Designation Term Limit and Re-Designations

All designations are valid for 5 years. Designations expire on the fifth anniversary of designation date shown on the designation certificate. Homes may be re-designated for additional 5-year terms by having a re-designation inspection at the end of each term. The re-designation inspection focuses on the roof covering and any substantive changes to systems covered under the FORTIFIED program. FORTIFIED homes seeking re-designation without re-roofing are only eligible for FORTIFIED Home – Existing Roof designation.

## 1.3 Scope of FORTIFIED Requirements

The FORTIFIED Home program is a voluntary program that only addresses wind and wind-driven rain aspects of risk. The requirements of the High Wind designation are intended to reduce risk due to severe thunderstorms, straight-line wind events, and high winds at the outer-most edges of tornadoes, while the requirements of the Hurricane designation are intended to reduce risk primarily due to tropical storms and hurricanes.

## 2 Eligibility and Minimum Requirements for all Designations

### 2.1 Applicable Regions

The FORTIFIED Home Standard provides program requirements for homes in both high-wind- and hurricane-prone regions of the United States as specified by the American Society of Civil Engineers Minimum Design Loads for Buildings and Other Structures (ASCE 7):

**Hurricane designations** are applicable for homes where the ultimate design wind speed ( $V_{ult}$ ) is greater than 115 mph as specified in ASCE 7-10 through ASCE 7-16 or the nominal design wind speed ( $V_{asd}$ ) is greater than 90 mph as specified in ASCE 7-98 through ASCE 7-05.

**High wind designations** are applicable for homes where the ultimate design wind speed ( $V_{ult}$ ) is equal to or less than 115 mph as specified in ASCE 7-10 through ASCE 7-16 or the nominal design wind speed ( $V_{asd}$ ) is equal to or less than 90 mph as specified in ASCE 7-98 through ASCE 7-05.

Refer to [section 2.10](#) for additional information about ultimate versus nominal wind speed.

**NOTE:** The Applied Technology Council (ATC) provides an online tool to easily determine design wind speed based on site address per ASCE 7-16, 7-10, and 7-05 (Refer to Risk Category II wind speeds): <https://hazards.atcouncil.org>. Always check local code requirements for wind speed as well, in case they differ from the wind speeds provided by the ATC website.

## 2.2 Qualifying Dwelling Types

The FORTIFIED Home program is only applicable for the residential, single-family and two-family dwelling types listed below. Note that residential structures that are either used for or converted into businesses fall under the FORTIFIED Commercial™ program and are NOT applicable for a FORTIFIED Home designation.

- ❑ **Single-family detached home**—a freestanding residential building occupied by one family. Limited to three stories above grade. This also includes detached single-family factory-built modular homes that are designed, built, and sited to meet all local building code requirements.
- ❑ **Two-family dwelling units (duplex)**—a freestanding residential building occupied by two families. Limited to three stories above grade. **NOTE:** The entire two-family building, which includes both dwelling units, must be evaluated under the appropriate FORTIFIED requirements and the entire building must meet all requirements for the designation being considered. Individual units are NOT eligible for designation unless the entire building is being designated.
- ❑ **HUD manufactured homes**—a single-family residential home manufactured to HUD's Zone II or Zone III Manufactured Home Construction and Safety Standards adopted after July 1994. The home must be sited on and properly attached to a permanent foundation (see foundation requirements in Section 1.2.3.3). HUD manufactured homes built before July 1994 and Zone I homes built after July 1994 are NOT eligible.
- ❑ **Townhouse**—a single-family dwelling unit constructed in a group of three or more attached units in which *each unit extends from foundation to roof and has a yard or public way on not less than two sides*. Limited to three stories above grade. Mixed use (commercial and residential) buildings are NOT eligible. **NOTE:** The entire townhouse building, which includes all townhouse units composing the building, must be evaluated under the appropriate FORTIFIED requirements and the entire building must meet all requirements for the designation being considered. Individual townhouse units are NOT eligible for designation unless the entire building is being designated. Example: A four-unit, two-story townhouse with all units attached is eligible for a specific FORTIFIED designation only if the entire building, including each and every townhouse unit, is evaluated and all units meet the requirements for that designation.

## 2.3 Ineligible Foundation Types

Homes on a foundation constructed of unrestrained stacked masonry or stone (a dry-stack foundation) are NOT eligible for any FORTIFIED designation. **NOTE:** Ineligible foundations may be retrofitted in accordance with a professional engineering plan and must comply with HUD-Code Manufactured Home foundation requirements (refer to [section 2.4](#) below) to be considered eligible.

### □ Unreinforced (dry-stack) foundations



Figure 2.1. Ineligible dry-stack foundation



Figure 2.2. Ineligible dry-stack foundation



Figure 2.3. Ineligible dry-stack foundation



## 2.4 Qualifying Foundation Types

Homes on a reinforced foundation may be eligible for FORTIFIED designation. Acceptable foundation types may include (but not necessarily be limited to) the following, provided that all subsequent requirements are met.

**Slab on grade**



Figure 2.4. Slab on grade

**Elevated-floor home-to-foundation connections**

To be eligible for designation or re-designation under the FORTIFIED program, **homes with elevated floors (not slab-on-grade construction) must have adequate positive connections from the floor or wall structure to the supporting foundation.** For example, homes on piers or pilings must have connections from the tops of the piers/pilings to the home's floor beams and a home on piers with shallow foundations must have connections that provide a continuous load path to the foundations. All connectors must be free from damage, corrosion-resistant (if applicable) in accordance with section 2.11 of this standard and installed per the connector manufacturer's installation instructions.



Figure 2.5. Crawlspace



**Figure 2.6. Stem wall**



**Figure 2.7. Post and beam/piling**

□ **HUD-code manufactured home foundations**

Foundations must be capable of resisting the design wind load requirements with no more than 1/4-in. lateral deflection. Requirements specified in the US Department of Housing and Urban Development (HUD) Permanent Foundation Guide for Manufactured Housing (HUD4930.3G) dated September 1996 or later provide useful assistance in identifying suitable foundation options. Based on results of past inspections of home installations that were reported as permanent, the following requirements of the HUD Guide and FORTIFIED requirements are emphasized and are part of the Field Evaluation inspection.

- Screw-in soil anchors are not considered a permanent anchorage and cannot be used as any part of the required permanent foundation unless their heads are restrained from lateral movement by embedment in a reinforced concrete footing or concrete slab.
- All concrete masonry unit (CMU) bearing walls, piers, and columns, as well as any units used as part of systems to resist uplift, overturning, and lateral loads must be composed of reinforced concrete masonry with mortared bed and head joints. Cells with reinforcing must be fully grouted. Dry-stacking of CMU is not allowed.
- All bearing walls, piers, and columns must be installed on and connected to acceptable footings or a concrete slab. Footings and slabs must be protected from the effects of frost heave by extending below the frost line or by using a frost-protected shallow foundation design.
- Walls and piers used as part of the uplift, overturning, or lateral load-resisting system must include adequately sized connections and elements capable of resisting tension or compression loads as appropriate. Straps or cables are acceptable, provided they are connected to the home or its chassis and transfer the design loads to the slab or footings supporting the walls, piers, or columns. Use of frictional resistance between the home or its chassis and the tops of the walls, piers, or columns or between the bottom of the walls, piers, or columns and the footings to resist lateral loads is not allowed.

## 2.5 Qualifying Roof Structural Members

- FORTIFIED Home specifications are applicable for wood framed roof structural members (i.e., wood trusses or rafters) with minimum 2 in. nominal thickness (1½ in. actual thickness), spaced at 24 in. O.C. maximum with wood structural panel sheathing (i.e., plywood or OSB). For wood roof framing outside of these parameters, a signed and sealed letter from a professional engineer (refer to [Appendix D](#) for definition) will be required to verify the sheathing is adequately rated for the span and applicable design wind pressures, and that the attachment of the sheathing to the roof framing members is adequate and in compliance with [Appendix B1](#).
  - Other construction materials and types of roof framing/sheathing shall be evaluated on a case-by-case basis. Materials, design, and installation must at minimum comply with local building code requirements, manufacturer specifications, and the design parameters listed below.
- Roof framing must be designed (by others) to support all gravity and wind loads corresponding to the site design wind speed, roof height, exposure category, and location on the building and all required load combinations in accordance with the applicable edition of ASCE 7 with the following minimum requirements:
  - To be eligible for FORTIFIED Gold designation, roof members must be designed for a minimum wind speed,  $V_{ult} = 130 \text{ mph} / V_{asd} = 100 \text{ mph}$  (refer to [section 2.10](#) for “ultimate” vs. “nominal” wind speed) and Exposure C (refer to [Appendix D](#) for definition).
    - Collar ties are required on all rafter pairs.

## 2.6 Qualifying Ring-Shank Nails

- Use minimum 8d (0.113-in. diameter) x 2¾-in. long roof sheathing ring-shank nails for connection of sheathing unless otherwise noted in FORTIFIED Home specifications.
- Ring-shank nails accepted by the FORTIFIED program shall comply with ASTM F1667. Only full round head ring-shank nails are acceptable. Off-center ring-shank nails with full round heads are acceptable. Clipped-head ring-shank nails are not acceptable for attachment of structural wood roof sheathing panels.

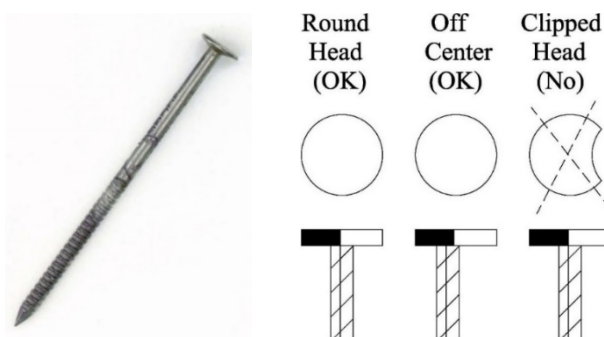

Figure 2.8. Ring-shank nail

## 2.7 Acceptable Debris Impact Ratings for Openings and Opening Covers

- Openings and opening covers described as “impact-rated” for debris in this FORTIFIED standard for FORTIFIED Roof, FORTIFIED Silver, and/or FORTIFIED Gold levels must be tested and approved at minimum in accordance with one of the following International Residential Code (IRC) accepted test standards for impact resistance (or with locally adopted standards if they are more restrictive) and installed in accordance with manufacturer’s instructions:

- Large Missile D (9 lb 2x4 impacting end on at 50 ft/sec) as defined in ASTM E1996 and ASTM E1886 and AAMA 506
- The Florida Building Code Testing Application Standards TAS 201 and TAS 203

**NOTE:** For additional hail impact rating requirements of the FORTIFIED Hail Supplement for skylights, refer to [section 7.4](#).

## 2.8 Acceptable Design Pressure (DP) Ratings

### 2.8.1 Acceptable Design Pressure (DP) Ratings for Roof Covers

- Roof cover systems described as “pressure-rated” or “DP-rated” in this FORTIFIED standard must have a certified design pressure report in compliance with one of the following, have DP ratings that meet or exceed site-specific required design pressures corresponding to a minimum of  $V_{ult} = 130$  mph and Exposure C, and must be installed in accordance with the manufacturer’s instructions:

- ICC-ES Evaluation Report
- Florida Product Approval
- Miami-Dade County Notice of Acceptance (NOA)
- Texas Department of Insurance (TDI) Evaluation Report

- DP ratings from organizations not listed above must incorporate a 2.0 safety factor by testing in accordance with **UL 580** or **UL 1897** or **TAS 125**.
  - UL 580 test report is acceptable for design uplift pressures **up to 52.5 psf maximum**.
  - For design uplift pressures greater than 52.5 psf, a UL 1897 test report will be required with design pressure ratings greater than or equal to the required design uplift pressures.
- FORTIFIED will not accept engineering extrapolation of test data (outside of the parameters set by the report/approval) to achieve greater DP ratings or larger connection spacings than listed in the certified report. Additionally, the installed product must match the tested assembly in the certified report.



## 2.8.2 Acceptable Design Pressure (DP) Ratings for Openings

- Openings described as “pressure-rated” in this FORTIFIED standard must be tested and approved at minimum, in accordance with one of the following International Residential Code (IRC) accepted pressure test standards (or with locally adopted standards if they are more restrictive), have DP ratings that meet or exceed site-specific required design pressures corresponding to a minimum of  $V_{ult} = 130$  mph and Exposure C, and must be installed in accordance with the manufacturer’s instructions:

**For windows, skylights, glass blocks, glass doors, and entry doors:**

- AAMA/WDMA/CSA 101/I.S.2/A440, ASTM E330 (products tested to 1.5 times design pressure)
- The Florida Building Code Testing Application Standard TAS 202

**For garage doors:**

- ANSI/DASMA 108 or ASTM E330 (products tested to 1.5 times design pressure)
- The Florida Building Code Testing Application Standard TAS 202

- FORTIFIED will not accept engineering rational analysis in lieu of testing to determine design pressure ratings. Additionally, the installed product must match the tested assembly in the certified report.

## 2.9 Referenced Codes and Standards

Codes and Standards referenced herein shall be the latest editions or as referenced in the locally adopted building code(s). Refer to [Appendix C](#) for list of references. Note the versions of ASCE 7 that are referenced in the following model codes:

IRC 2021 → ASCE 7-16

IRC 2018 → ASCE 7-16

IRC 2015 → ASCE 7-10

IRC 2012 → ASCE 7-10

IRC 2009 → ASCE 7-05

IRC 2006 → ASCE 7-05

IRC 2003 → ASCE 7-02

IRC 2000 → ASCE 7-98

## 2.10 Ultimate vs. Nominal Wind Speed ( $V_{ult}$ vs. $V_{asd}$ )

Where ultimate wind speed ( $V_{ult}$ ) or nominal windspeed ( $V_{asd}$ ) are referenced herein, it must be determined which edition of the American Society of Civil Engineers Minimum Design Loads for Building and Other Structures (ASCE 7) Standard is referenced by the locally adopted building code(s) (refer to [section 2.9](#)). Ultimate wind speed ( $V_{ult}$ ) is the wind speed determined in accordance with either ASCE 7-10 or ASCE 7-16 and nominal wind speed ( $V_{asd}$ ) is the wind speed determined in accordance with ASCE 7-98 through ASCE 7-05. Use the wind speed that corresponds to the version of ASCE 7 referenced by the locally adopted building code(s) for the site. Figure 2.9 provides a conversion chart for ultimate to nominal wind speed and vice versa.

<b>Design Wind Speed Conversion Chart</b>			
<b><i>Ultimate to Nominal</i></b>		<b><i>Nominal to Ultimate</i></b>	
$V_{ult}$ (mph)	$V_{asd}$ (mph)	$V_{asd}$ (mph)	$V_{ult}$ (mph)
115	89	80	103
120	93	90	116
130	101	100	129
140	108	110	142
150	116	120	155
160	124	130	168
170	132	140	181
180	139	150	194

**Figure 2.9. Ultimate vs. Nominal Design Wind Speed Conversion Chart**

## 2.11 Corrosion Protection Requirements for Fasteners and Connectors in Coastal Regions

Installed hardware must comply with the FORTIFIED Fastener and Connector Corrosion Protection Requirements Table shown below and also provided in FORTIFIED Standard Detail [F-G-1](#) “Corrosion Protection Requirements” (refer to Appendix A). For all connections described in this table, if corrosion is observed at time of re-designation, designation may not be renewed.

Requirements & Best Practices for FORTIFIED Roof™ Designations			
	REQUIREMENTS		BEST PRACTICES
	<i>Distance to saltwater shoreline<sup>1</sup></i>		
	0–300 ft	300–3,000 ft	Distance to brackish water shoreline 0–300 ft
<b>ROOF CONNECTIONS</b>			
Roofing nails for shingles	Category A	Category B (or better)	Category B (or better)
Concrete and clay roof tile fasteners			
Roof vent fasteners			
Metal roof system including panels and exposed fasteners, clips, etc.	Follow manufacturer's corrosion resistance guidance for coastal areas. If not provided by manufacturer, the following corrosion resistance categories may be accepted for exposed fasteners and clips		
	Category A	Category B (or better)	
Fasteners used for attachment of underlayment to roof deck	Category B (or better)		
Roof-mounted equipment exposed connections and fasteners	Category A	Category B (or better)	
Requirements and Best Practices for FORTIFIED Silver™ and FORTIFIED Gold™ Designations			
	REQUIREMENTS		BEST PRACTICES
	<i>Distance to saltwater shoreline<sup>1</sup></i>		
	0–300 ft	300–3,000 ft	Distance to brackish water shoreline 0–300 ft
<b>EXTERIOR EXPOSED CONNECTIONS</b> (including under soffits and elevated foundations)			
<b>Silver:</b>	Category A	Category B (or better)	Category B (or better)
• Soffit fasteners			
• Exposed attached structure connectors, anchors, fasteners	<i>Aluminum Soffits NOT Allowed</i>	<i>Aluminum Soffits Allowed</i>	
<b>Gold:</b> Exposed CLP connectors, anchors, fasteners			
	BEST PRACTICES		BEST PRACTICES
	<i>Distance to saltwater shoreline<sup>1</sup></i>		
	0–300 ft	300–3,000 ft	Distance to brackish water shoreline 0–300 ft
<b>INTERIOR CONNECTIONS</b> (including enclosed in attic or within wall cavity)			
<b>Silver:</b>	Category B (or better)		Category C (or better)
• Gable bracing metal connectors and fasteners			
• Gable outlooker hangers, clips and fasteners			
• Chimney framing metal connectors and fasteners			
<b>Gold:</b> Enclosed CLP connectors, anchors, fasteners	Category C (or better)		

[F-G-1](#)

Corrosion Resistance Categories <sup>2,3</sup>	
<p><b>CATEGORY A: STAINLESS STEEL OR EQUIVALENT</b></p> <p><u>Metal connectors:</u></p> <ul style="list-style-type: none"> <li>Stainless steel per ASTM A316</li> </ul> <p><u>Fasteners:</u></p> <ul style="list-style-type: none"> <li>Stainless steel per ASTM A304 or A316</li> <li>Proprietary coated fasteners require documentation of equivalent corrosion protection performance to stainless steel, such as equivalence testing per <b>ICC-ES AC257 Exposure Condition 4</b>, or other comparative testing documentation</li> </ul> <p><b>CATEGORY C: STANDARD GALVANIZED</b></p> <p><u>Metal connectors:</u></p> <ul style="list-style-type: none"> <li>Galvanized per ASTM A653 with G90 coating</li> </ul> <p><u>Fasteners:</u></p> <ul style="list-style-type: none"> <li>Galvanized per ASTM A641 Class 1</li> </ul>	<p><b>CATEGORY B: ENHANCED GALVANIZED OR EQUIVALENT</b></p> <p><u>Metal connectors:</u></p> <ul style="list-style-type: none"> <li>Galvanized per ASTM A653 with G185 coating</li> <li>Hot-dip galvanized per ASTM A123</li> </ul> <p><u>Fasteners with diameters over 3/8 in.:</u></p> <ul style="list-style-type: none"> <li>Hot-dip galvanized per ASTM A153 Class C</li> </ul> <p><u>Fasteners with diameters up to 3/8 in. shall meet one of the following:</u></p> <ul style="list-style-type: none"> <li>Hot-dip galvanized per ASTM A153 Class D</li> <li>Galvanized per ASTM A641 Class 3</li> <li>Per ASTM G85, Annex 5, Corrosion resistance exhibiting not more than 5% red rust after the following: <ul style="list-style-type: none"> <li>— <b>for nails:</b> 280 hours</li> <li>— <b>for roof tile fasteners:</b> 1000 hours</li> <li>— <b>for other carbon steel fasteners:</b> 360 hours</li> </ul> </li> <li>In lieu of testing listed above, proprietary coated fasteners require documentation of equivalent or superior corrosion protection performance to the galvanization options listed above, such as equivalence testing per <b>ICC-ES AC257 Exposure Condition 4</b>, or other comparative testing documentation</li> <li>Testing per ASTM B117 with corrosion resistance exhibiting not more than 5% red rust after 1,000 hours exposure may be accepted if no other testing is available</li> </ul>
<p><b>NOTES</b></p> <ol style="list-style-type: none"> <li>For the purposes of FORTIFIED Home designation, “saltwater shoreline” shall be considered as the ocean or gulf coastline along the mainland United States including seaward island coastlines. This includes the Atlantic, Pacific, and Gulf of Mexico coastlines, as well as the coastline of any Bay or Sound with no land barrier separating it from being completely open to the ocean or Gulf of Mexico. Distances are measured from the closest feature of the subject building to the ocean or gulf coastline.</li> <li>Fastener and connector materials and coatings must be compatible with materials and coatings they come into contact with to prevent galvanic corrosion due to dissimilar materials.</li> <li>Fasteners in contact with chemically treated wood shall be in accordance with the requirements of the IBC/IRC or locally adopted code as applicable.</li> </ol>	

**F-G-1 (continued)**

## 2.12 Documentation Requirements

Appropriate and adequate documentation must be provided to IBHS to achieve a FORTIFIED designation for all levels (FORTIFIED Roof, FORTIFIED Silver, and FORTIFIED Gold). Installation documentation is intended to enforce that FORTIFIED requirements have been followed and installed as required onsite, and that adequately rated products have been chosen and installed in compliance with manufacturer requirements. Installation documentation may include but is not limited to the following depending on designation level:

- Photo documentation of product packaging
- Photo documentation of installation
- Certified testing reports and/or manufacturer installation instructions for certain products
- FORTIFIED Compliance Forms

Submitted documentation must be unique to the site address receiving designation and must be of satisfactory image quality and/or resolution so that it is legible and easily deciphered. Failure to submit adequate documentation may result in denial of FORTIFIED designation. Full listings of minimum documentation requirements for all designation levels are available on the [FORTIFIED Home website](#).

## 2.13 Recommendations for Flood Mitigation

Because elevation of an existing home to avoid flood damage is a cost-prohibitive expense for many homeowners, this program only addresses wind and wind-driven rain aspects of risk. **IBHS recommends that homes be built at an elevation corresponding to a 1-in-500 chance of flooding per year or a minimum of 3 ft above the base flood elevation (the base flood elevation corresponds to a 1-in-100 chance of flooding per year).** Best practice for new home construction is to build to these higher elevations.

## 2.14 Appropriate Use of FORTIFIED

FORTIFIED Home requirements are minimum requirements and do not take the place of structural design or supersede more restrictive requirements from the structural design, locally adopted building code(s), or product manufacturer's specifications.

The FORTIFIED Home Standard is to be applied in conjunction with federal, state, and local codes, ordinances and regulations in addition to the structural design which is by others. In case of a conflict between provisions, use whichever is more stringent.

# 3 Designation Requirements for FORTIFIED Roof – Existing Roof

The FORTIFIED Roof – Existing Roof designation provides prescriptive methods to create a qualified roof without requiring roof covering replacement on an existing home. From [section 1.1](#):

*Existing Roof designations are appropriate for existing homes that have a roof and roof covering with greater than 5 useful years of life remaining that do not show visible signs of damage or deterioration. FORTIFIED homes seeking re-designation without re-roofing are only eligible for an Existing Roof designation. Similarly, newly installed roofs where the roof sheathing, sealed roof deck, and/or roof cover installation or wind rating cannot be verified are only eligible for an Existing Roof designation.*

This approach may be used when roof covering replacement is determined to be unnecessary if ALL the following requirements of this section are met. If one or more of the following requirements are not met, then re-roofing in accordance with [section 4](#) is required.

## 3.1 Roof Deck and Roof Cover

- Roof structural members must meet the requirements of [section 2.5](#).
- Roof sheathing must meet the following minimum thickness requirements:

### For Hurricane Designations

Table 3.1. Roof Sheathing Minimum Thickness Requirements for FORTIFIED Home–Hurricane

Max. Roof Member Spacing	ASCE 7-10	ASCE 7-16
24" O.C.	7/16"	15/32"

### For High Wind Designations

Table 3.2. Roof Sheathing Minimum Thickness Requirements for FORTIFIED Home–High Wind

Max. Roof Member Spacing	FORTIFIED Roof		FORTIFIED Silver		FORTIFIED Gold	
	ASCE 7-10	ASCE 7-16	ASCE 7-10	ASCE 7-16	ASCE 7-10	ASCE 7-16
16" O.C.	3/8"	3/8"	3/8"	3/8"	7/16"	7/16"
24" O.C.	7/16"	15/32"	7/16"	15/32"	7/16"	15/32"



**NOTE:** Local building code requirements for roof sheathing thickness may be more stringent based on site conditions. Refer to [section 2.9](#) for additional information regarding ASCE 7 editions referenced by different model building codes.

- The existing roof cover does not show visible signs of damage or deterioration.
- There is only one layer of roof covering.
  - **NOTE:** Although some jurisdictions allow a new roof to be installed over an existing roof, FORTIFIED requires existing roof covering be removed to the deck before installing a new roof cover system.
- Existing roof covering is estimated to have at least 5 years of useful life remaining
- There is adequate access to the attic to allow application of closed-cell spray urethane-based foam adhesives along joints between sheathing and roof framing members as well as along all seams between the roof sheathing panels.
- Drip edge is installed.

For FORTIFIED Hail Supplement requirements, refer to [section 7.2 or 7.3](#) as applicable.

### 3.2 Sealing and Strengthening of Roof Deck

- Apply ASTM or TAS tested 2-part, spray polyurethane foam adhesive to the underside of the roof deck in accordance with FORTIFIED Standard Detail [F-SRD-1](#) “Roof Deck Attachment and Sealed Roof Deck from Within Using Spray Foam” (refer to Appendix A).



**Figure 3.1. Closed-cell polyurethane foam adhesive applied to underside of roof sheathing**

<p><b>MINIMUM REQUIREMENTS FOR SPRAY ADHESIVES</b></p> <ol style="list-style-type: none"> <li>1. PRODUCT MUST BE TESTED AND EVALUATED IN ACCORDANCE WITH EITHER ASTM E330, STANDARD TEST METHOD FOR STRUCTURAL PERFORMANCE OF EXTERIOR WINDOWS, DOORS, SKYLIGHTS, AND CURTAIN WALLS BY UNIFORM STATIC AIR PRESSURE DIFFERENCE (APPLIED TO ROOF SHEATHING) OR TAS 202-94, CRITERIA FOR TESTING IMPACT AND NON-IMPACT RESISTANT BUILDING ENVELOPE COMPONENTS USING UNIFORM STATIC AIR PRESSURE. THE MINIMUM ALLOWABLE DESIGN UPLIFT PRESSURE MUST BE GREATER THAN OR EQUAL TO 110 PSF AND THE PROOF TEST PRESSURE ACHIEVED WITHOUT FAILURE OR STRUCTURAL DISTRESS MUST BE GREATER THAN OR EQUAL TO 165 PSF.</li> <li>2. ADHESIVE MUST BE A TWO-COMPONENT SPRAY POLYURETHANE FOAM SYSTEM WITH A MINIMUM CORE DENSITY OF 1.5-3.0 PCF IN ACCORDANCE WITH ASTM D1622, STANDARD TEST METHOD FOR APPARENT DENSITY OF RIGID CELLULAR PLASTICS.</li> <li>3. SPRAY POLYURETHANE FOAM ADHESIVE SYSTEM MUST BE INSTALLED BY A PROPERLY TRAINED AND QUALIFIED APPLICATOR IN ACCORDANCE WITH THE MANUFACTURER'S MAINTENANCE AND INSTALLATION GUIDELINES.</li> <li>4. DOCUMENTATION FROM THE INSTALLING CONTRACTOR, ON COMPANY LETTERHEAD, IDENTIFYING THE MANUFACTURER AND PRODUCT USED FOR THE IMPROVED ROOF SHEATHING ATTACHMENT/SEALED ROOF DECK MUST BE PROVIDED TO THE CERTIFIED FORTIFIED EVALUATOR TO BE INCLUDED WITH FINAL DESIGNATION CHECKLIST. DOCUMENTATION SHOULD ALSO STATE THAT THE INSTALLATION MEETS THE MANUFACTURER'S REQUIREMENTS FOR AN ALLOWABLE DESIGN UPLIFT PRESSURE OF AT LEAST 110 PSF (PROOF TEST OF AT LEAST 165 PSF).</li> <li>5. USE THE MINIMUM DENSITY AND INSTALLATION REQUIREMENTS PRESCRIBED BY THE MANUFACTURER TO MEET A MINIMUM DESIGN UPLIFT PRESSURE OF 110 PSF FOR HURRICANE OR 80 PSF FOR HIGH WIND.</li> </ol>	<p><b>GENERAL NOTES:</b></p> <ol style="list-style-type: none"> <li>1. REFER TO APPROPRIATE FORTIFIED HOME STANDARDS FOR ADDITIONAL INFORMATION.</li> <li>2. EXISTING SHEATHING REQUIREMENTS: EXISTING SHEATHING: 7/8" MIN. THICKNESS REQUIRED WITH ROOF MEMBERS @ 24" O.C. MAX. EQUAL WIND: 7/8" MIN. THICKNESS IS REQUIRED FOR COLD DESIGNATION. FOR ROOF/SILVER DESIGNATION, 3/8" MIN. THICKNESS IS PERMITTED WHEN ROOF MEMBERS ARE @ 24" O.C. MAX.</li> <li>3. FORTIFIED HOME STANDARDS ARE TO BE APPLIED IN CONJUNCTION WITH FEDERAL, STATE, AND LOCAL CODES, ORDINANCES, AND REGULATIONS IN ADDITION TO THE STRUCTURAL DESIGN WHICH IS BY OTHERS. IN CASE OF A CONFLICT BETWEEN PROVISIONS, USE WHICHEVER IS MORE STRINGENT.</li> </ol>		
<p>UNDERSIDE OF ROOF DECK FROM WITHIN ATTIC</p>			
	<p><b>APPLICABLE STANDARDS:</b></p> <p>FORTIFIED 110-HW<sup>1</sup>   L1503KHC 2020 FORTIFIED HOME<sup>SM</sup> - HIGH WIND 02020</p>	<p><b>DESCRIPTION:</b></p> <p>STEEP SLOPE ROOF DECK ATTACHMENT AND SEALED ROOF DECK FROM WITHIN USING SPRAY FOAM</p>	<p><b>DRAWING #:</b></p> <p>F-SRD-1</p> <p><b>DATE:</b></p> <p>11/01/2020</p>

**F-SRD-1**

EXISTING ROOF

**Closed-Cell Polyurethane Foam Adhesive Minimum Requirements**

- Product must be tested and evaluated in accordance with either ASTM E330, Standard Test Method for Structural Performance of Exterior Windows, Doors, Skylights and Curtain Walls by Uniform Static Air Pressure Difference (applied to roof sheathing), or TAS 202-94, Criteria for Testing Impact and Non-Impact Resistant Building Envelope Components Using Uniform Static Air Pressure. The minimum allowable design uplift pressure must be greater than or equal to 110 psf and the proof test pressure achieved without failure or structural distress must be greater than or equal to 165 psf.
- Adhesive must be a two-component spray polyurethane foam system with a minimum core density of 1.5–3.0 pcf in accordance with ASTM D1622, Standard Test Method for Apparent Density of Rigid Cellular Plastics.
- Spray polyurethane foam adhesive system must be installed by a properly trained and qualified applicator in accordance with the manufacturer’s maintenance and installation guidelines.
- Documentation from the installing contractor, on company letterhead, identifying the manufacturer and product used for the improved roof sheathing attachment/sealed roof deck must be provided to the certified FORTIFIED Evaluator to be included with final designation checklist. Documentation should also state that the installation meets the manufacturer’s requirements for an allowable design uplift pressure of at least 110 psf (proof test of at least 165 psf).

**Closed-Cell Polyurethane Foam Adhesive Installation**

To provide enhanced roof sheathing attachment and to seal the roof deck, apply a 1.5- to 3-in. fillet of 2-part spray-applied polyurethane foam adhesive to:

- All joints between sheathing
- All intersections between roof sheathing and roof framing members
- All valleys

Spray adhesive application shall comply with the manufacturer’s installation requirements and the density shall not be less than that required by the manufacturer to meet a minimum design uplift pressure on the sheathing of the following:

**For Hurricane designation: 110 psf**

**For High Wind designation: 80 psf**

**EXCEPTION:** If it can be demonstrated through inspection and documentation that the roof sheathing attachment meets or exceeds one of the following requirements AND that a qualified sealed roof deck system is installed, then the installation of closed-cell foam is not required:

1. Wood board roof deck must meet or exceed the requirements of FORTIFIED Standard Detail [F-RS-1](#) “Roof Deck Attachment – Sawn Lumber or Wood Board Roof Deck with No Gaps” (refer to Appendix A).
2. Structural wood panel sheathing must meet or exceed the requirements of:

**For Hurricane designation:** FORTIFIED Standard Detail [F-RS-2](#) “Hurricane – New Construction Roof Deck Attachment – Structural Wood Panels” (refer to Appendix A)

**For High Wind designation:** FORTIFIED Standard Detail [F-RS-3](#) “High Wind – New Construction Roof Deck Attachment – Structural Wood Panels” (refer to Appendix A)

3. Roof sheathing attachment meets or exceeds the requirements outlined in [Appendix B1](#).

### 3.3 Attic Vents and Covers (Hurricane Designation Only)

- ❑ Ridge and off-ridge vents must be TAS 100(A) rated and anchored to the roof in compliance with manufacturer recommended installation for high winds.
- ❑ Gable end vents must have removable shutters in accordance with FORTIFIED Standard Detail **F-GS-1** “Gable Vent Shuttering” (refer to Appendix A), and homeowner must be made aware that installation of shutters is temporary and that shutters must be removed once the hurricane threat has passed.



Figure 3.2. Example of a gable end vent with



Figure 3.3. Outside shuttering of a gable end vent



Figure 3.4. Shuttering of gable end vent from inside attic

#### Plywood

**GENERAL NOTES:**

- REFER TO APPLICABLE FORTIFIED HOME STANDARDS FOR ADDITIONAL INFORMATION.
- REFER TO FORTIFIED STANDARD DETAIL F-GS-1 FOR CORROSION PROTECTION REQUIREMENTS.
- TO MAINTAIN PROPER ATTIC VENTILATION, VENT SHUTTERING MAY BE PERFORMED ON A TEMPORARY BASIS ONLY AND SHUTTERS ARE TO BE REMOVED AFTER A STORM THREAT IS OVER. ADEQUATE ATTIC VENTILATION MUST BE MAINTAINED ON A REGULAR BASIS.**
- FORTIFIED HOME STANDARDS ARE TO BE APPLIED IN CONJUNCTION WITH FEDERAL, STATE, AND LOCAL CODES, ORDINANCES AND REGULATIONS IN ADDITION TO THE STRUCTURAL DESIGN WHICH IS BY OTHERS. IN CASE OF A CONFLICT, BETWEEN PROVISIONS, USE WHICHEVER IS MORE STRINGENT.

WOOD STRUCTURAL PANEL OR OTHER NONPOROUS FLAT SHUTTER CUT TO FIT W/ 3/8" MIN. THICKNESS. PRE-DRILL HOLES AT FASTENER LOCATIONS. SPACING MAY VARY, BUT NOT TO EXCEED MAX. DIMENSIONS AND FASTENER SPACING SHOWN.

OUTLINE OF CABLE VENT BEYOND SHUTTER

16" O.C. MAX.

PERMANENT, CORROSION RESISTANT FASTENER THROUGH PRE-DRILLED HOLES REFER TO TABLE F-GS-1 FOR FASTENER INFORMATION. MINIMUM OF (2) FASTENERS PER EACH PANEL SIDE REQUIRED.

2"

4'-0" MAX.

(REFER TO TABLE F-GS-1)

SHUTTER CAN BE INSTALLED FROM OUTSIDE OF HOUSE OR FROM INSIDE OF ATTIC.

NOTE: SELF-ADHESIVE WEATHER STOPPING CAN BE USED TO SEAL THE SHUTTERS TO THE FRAMING AROUND VENT EDGES IF SHUTTERS ARE INSTALLED ON INSIDE OF ATTIC. ENSURE THAT ANY WATER THAT ACCUMULATES IN THE CAVITY CAN DRAIN TO THE OUTSIDE OF THE HOUSE AND NOT INTO THE WALL BELOW.

NOTE: W/ 3/8" SCREWS ARE ATTACHED TO MASONRY OR MASONRY BLOCK. USE VIBRATION RESISTANT ANCHORS W/ 1500 LBS MIN. WITHDRAWAL CAPACITY.

SUPPORT STRUCTURE TYPE	FASTENER TYPE & SIZE	END DISTANCE, D
WOOD	1/4" Ø LAG SCREWS W/ 2" EMBEDMENT & 1" Ø WASHER	1"
CONCRETE OR CROUTED MASONRY	1/4" Ø FASTENER W/ 2" EMBEDMENT & 1" Ø WASHER	1.5"

	<b>APPLICABLE STANDARDS:</b> FORTIFIED HOME™ (FHS) REGULATIONS (2020)	<b>DESCRIPTION:</b> TEMPORARY CABLE VENT SHUTTERING	<b>DRAWING #:</b> F-GS-1
			<b>DATE:</b> 11/01/2020

**F-GS-1**

## 3.4 Photovoltaic (PV) Systems

- Letter of compliance required from professional engineer indicating that connections and installation of the PV system meet the design intent, and that system has been appropriately designed for the following:
  - Roof-mounted PV systems shall be designed for component and cladding wind loads for the site in accordance with ASCE 7 using an effective area based on the dimensions of a single unit frame.
  - The roof deck and supporting structure must be designed to support all gravity and wind loads resulting from the PV system installation.
- All roof penetrations must be sealed and flashed in accordance with the PV system and roof covering manufacturer's requirements.

For **FORTIFIED Hail Supplement** requirements, refer to [section 7.5](#).

# 4 Designation Requirements for FORTIFIED Roof – New Roof

The FORTIFIED Roof – New Roof designation provides prescriptive methods for installing a roof on a new home or re-roofing an existing home. Re-roofing is required when one or more of the requirements outlined in [section 3](#) are not met. From [section 1.1](#):

*New Roof designations are only appropriate for new construction or re-roofing projects where all roof sheathing, sealed roof deck, and roof covering systems are newly installed (less than 5 years old) and installation in compliance with FORTIFIED Home requirements is verifiable at the time of designation ... newly installed roofs where the roof sheathing, sealed roof deck, and/or roof cover installation or wind rating cannot be verified are only eligible for an Existing Roof designation.*

## 4.1 Roof Deck Minimum Thickness Requirements

- Roof structural members must meet the requirements of [section 2.5](#).
- Roof sheathing must meet the following minimum thickness requirements:

### For All Hurricane Designations

Table 4.1. Roof Sheathing Minimum Thickness Requirements for FORTIFIED Home–Hurricane

Max. Roof Member Spacing	ASCE 7-10	ASCE 7-16
24" O.C.	7/16"	15/32"

### For High Wind Designations

Table 4.2. Roof Sheathing Minimum Thickness Requirements for FORTIFIED Home–High Wind

Max. Roof Member Spacing	FORTIFIED Roof		FORTIFIED Silver		FORTIFIED Gold	
	ASCE 7-10	ASCE 7-16	ASCE 7-10	ASCE 7-16	ASCE 7-10	ASCE 7-16
16" O.C.	3/8"	3/8"	3/8"	3/8"	7/16"	7/16"
24" O.C.	7/16"	15/32"	7/16"	15/32"	7/16"	15/32"

NEW ROOF



- **EXCEPTION:** for new clay or concrete tile roofs, roof sheathing must have minimum thickness of  $1^{5}/_{32}$  in. per the FRSA/TRI Florida High Wind Concrete and Clay Tile Installation Manual, Revised 5<sup>th</sup> Edition (for ASCE 7-10) or 6<sup>th</sup> Edition (for ASCE 7-16) requirements or greater thickness if required by tile manufacturer. For metal roof covers, verify manufacturer's sheathing thickness requirements are met.
- **NOTE:** Local building code requirements for roof sheathing thickness may be more stringent based on-site conditions.
- Refer to [section 2.9](#) for additional information regarding ASCE 7 editions referenced by different model building codes.
- Sawn lumber or wood board roof decking members must have  $5/8$  in. minimum thickness.
- Roof sheathing must be designed to resist the applicable loads and load combinations specified in ASCE 7 per either engineering analysis or prescriptive method.
  - FORTIFIED Home requirements are based on minimums of  $V_{ult} = 130$  mph and Exposure C. For conditions that exceed these minimums, refer to WFCM Table 3.12A (2015 Edition for ASCE 7-10 or 2018 Edition for ASCE 7-16) for prescriptive guidance.
  - **BEST PRACTICE:** IBHS recommends using plywood for roof sheathing in lieu of oriented strand board (OSB).

## 4.2 Attachment of New Roof Deck Only

### 4.2.1 Attachment of Wood Board Roof Sheathing

- Attachment of sawn lumber or wood board roof decking to roof structural members shall be in accordance with FORTIFIED Standard Detail [F-RS-1](#) "Roof Deck Attachment – Sawn Lumber or Wood Board Roof Deck with No Gaps" (refer to Appendix A) and Table F-RS-1.

**Table F-RS-1. From F-RS-1: Minimum Requirements for Wood Board Lumber Sheathing**

Wood Board/Lumber (Roof Decking) Width	Number and Minimum Dimensions of Nails per Board for Each Framing Member it Crosses
Up to 8"	Two (2) 0.131" $\varnothing$ min. w/ 1 $\frac{5}{8}$ " penetration into roof framing members (min. length of nail = 2 $\frac{1}{2}$ " )
Larger than 8"	Three (3) 0.131" $\varnothing$ min. w/ 1 $\frac{5}{8}$ " penetration into roof framing members (min. length of nail = 2 $\frac{1}{2}$ " )

**NOTE:** Clipped-head, D-head, or round-head nails shall be acceptable provided they have the required minimum diameter and length.

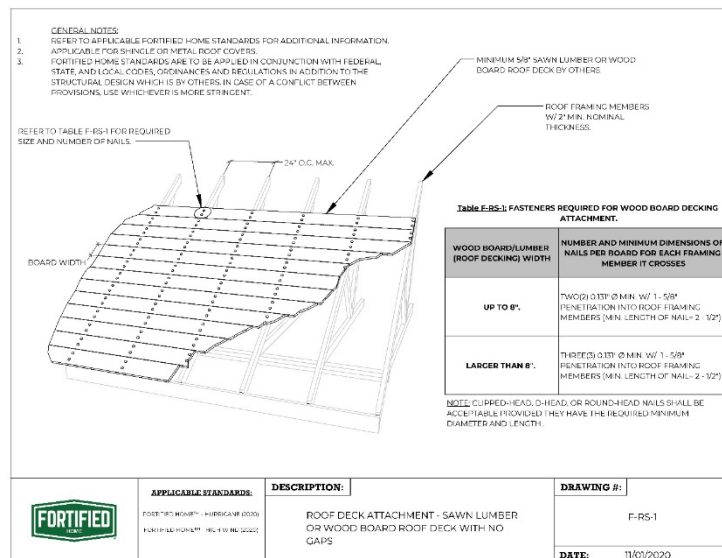

### [F-RS-1](#)

### 4.2.2 Attachment of Wood Structural Panel Roof Sheathing (Plywood or OSB)

- Ring-shank nails shall meet the requirements of [section 2.6](#).
- Attachment of structural wood panel roof sheathing to roof structural members shall be in accordance with the following (refer to Appendix A for FORTIFIED Standard Details):

NEW ROOF

**For Hurricane designation: F-RS-2 "Hurricane – New Construction Roof Deck Attachment – Structural Wood Panels" and Table F-RS-2.**

**Table F-RS-2. From F-RS-2: Minimum Requirements for Roof Sheathing Fastening for Hurricane**

ASCE Edition	Minimum Roof Sheathing Thickness <sup>1,2,3</sup>	Minimum Nail Size/Type <sup>1,4</sup>	Maximum Nail Spacing (All Roof Areas) <sup>1</sup>
ASCE 7-10	7/16" <i>See Notes 1, 2, 3</i>	RSRS-01; 0.113" dia. x 2-3/8" Roof Sheathing Ring Shank Nail	4" O.C.
ASCE 7-16	15/32" <i>See Notes 1, 3</i>		

**Notes:**

1. Local building code requirements for roof sheathing thickness and/or nail size/attachment spacing may be more stringent based on site conditions.
2. For concrete and clay tile roof covers, minimum required sheathing thickness is 15/32".
3. For metal roof covers, verify manufacturer's sheathing thickness requirements are met.
4. Full round head Ø; No clipped-head nails, common nails or staples shall be allowed. Refer to Figure 1.

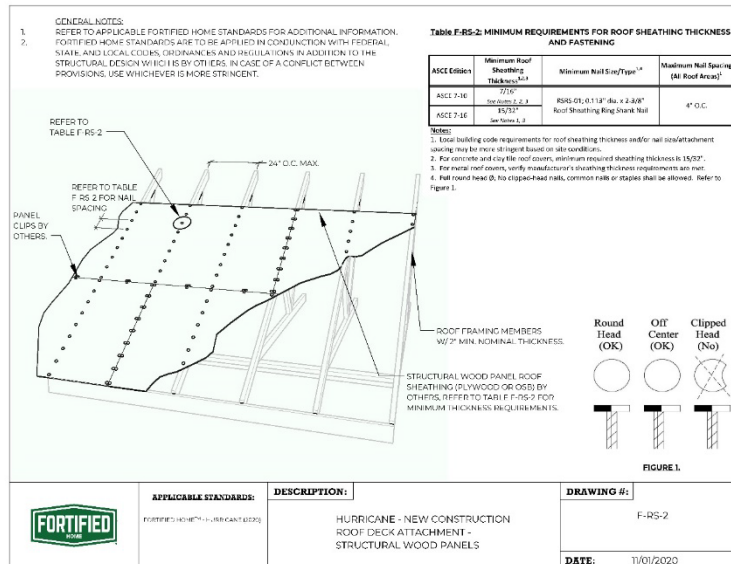

**F-RS-2**

**For High Wind Designation: F-RS-3. "High Wind - New Construction Roof Deck Attachment – Structural Wood Panels" and Table F-RS-3.**

**Table F-RS-3. From F-RS-3: Minimum Requirements for Roof Sheathing Fastening for High Wind**

ASCE Edition	Minimum Roof Sheathing Thickness <sup>1,2,3</sup>				Minimum Nail Size/Type <sup>1,4</sup>	Maximum Nail Spacing (All Roof Areas) <sup>1</sup>
	Roof members @ 16" O.C. Max.		Roof Members @ 24" O.C. Max.			
	FORTIFIED Levels: Roof and Silver	FORTIFIED Level: Gold	FORTIFIED Levels: Roof and Silver	FORTIFIED Level: Gold		
ASCE 7-10	3/8"	7/16"	7/16"	7/16"	RSRS-01; 0.113" dia. x 2-3/8" Roof Sheathing Ring Shank Nail	6" O.C.
	<i>See Notes 1, 2, 3</i>	<i>See Notes 1, 2, 3</i>	<i>See Notes 1, 2, 3</i>	<i>See Notes 1, 2, 3</i>	8d Common Nail; 0.131" dia. X 2-1/2"	4" O.C.
ASCE 7-16	3/8"	7/16"	15/32"	15/32"	RSRS-01; 0.113" dia. x 2-3/8" Roof Sheathing Ring Shank Nail	4" O.C.
	<i>See Notes 1, 2, 3</i>	<i>See Notes 1, 2, 3</i>	<i>See Notes 1, 3</i>	<i>See Notes 1, 3</i>	<i>Common Nails Not an Option</i>	N/A

**Notes:**

1. Local building code requirements for sheathing thickness and/or nail size/attachment spacing may be more stringent based on site conditions.
2. For concrete and clay tile roof covers, minimum required sheathing thickness is 15/32".
3. For metal roof covers, verify manufacturer's sheathing thickness requirements are met.
4. Full round head Ø; No clipped-head nails, common nails or staples shall be allowed. Refer to Figure 1.

**GENERAL NOTES:**

1. REFER TO APPLICABLE FORTIFIED HOME STANDARDS FOR ADDITIONAL INFORMATION.
2. TO BE FORTIFIED FOR GOLD DESIGNATION, ROOF MEMBERS MUST BE DESIGNED FOR MINIMUM V<sub>W</sub> = 100 MPH DESIGN WIND LOADS AND TERRAIN EXPOSURE C. FORTIFIED HOME STANDARDS ARE TO BE APPLIED IN CONJUNCTION WITH FEDERAL, STATE, AND LOCAL CODES, ORDINANCES AND REGULATIONS IN ADDITION TO THE STRUCTURAL DESIGN WHICH IS IN OTHERS. IN CASE OF A CONFLICT, THE MORE PROTECTIVE USE, WHICH EVER IS MORE STRINGENT.

ROOF FRAMING MEMBERS W/ 2" MIN. NOMINAL THICKNESS. REFER TO GENERAL NOTE #3.

REFER TO TABLE F-RS-3.

REFER TO TABLE F-RS-3.

REFER TO TABLE F-RS-3 FOR NAIL SPACING.

PANEL CLIPS BY OTHERS.

STRUCTURAL WOOD PANEL, ROOF SHEATHING OR WOOD OR OSB BY OTHERS. REFER TO TABLE F-RS-3 FOR MINIMUM THICKNESS REQUIREMENTS.

**Table F-RS-3: MINIMUM REQUIREMENTS FOR ROOF SHEATHING THICKNESS AND FASTENING**

ASCE Edition	Minimum Roof Sheathing Thickness <sup>1,2,3</sup>				Minimum Nail Size/Type <sup>1,4</sup>	Maximum Nail Spacing (All Roof Areas) <sup>1</sup>
	FORTIFIED Levels: Roof and Silver	FORTIFIED Level: Gold	FORTIFIED Levels: Roof and Silver	FORTIFIED Level: Gold		
ASCE 7-10	3/8" <i>See Notes 1, 2, 3</i>	7/16" <i>See Notes 1, 2, 3</i>	7/16" <i>See Notes 1, 2, 3</i>	7/16" <i>See Notes 1, 2, 3</i>	RSRS-01; 0.113" dia. x 2-3/8" Roof Sheathing Ring Shank Nail	6" O.C.
ASCE 7-10	3/8" <i>See Notes 1, 2, 3</i>	7/16" <i>See Notes 1, 2, 3</i>	15/32" <i>See Notes 1, 3</i>	15/32" <i>See Notes 1, 3</i>	8d Common Nail; 0.131" dia. X 2-1/2"	4" O.C.
ASCE 7-16	3/8" <i>See Notes 1, 2, 3</i>	7/16" <i>See Notes 1, 2, 3</i>	15/32" <i>See Notes 1, 3</i>	15/32" <i>See Notes 1, 3</i>	RSRS-01; 0.113" dia. x 2-3/8" Roof Sheathing Ring Shank Nail	4" O.C.
ASCE 7-16	3/8" <i>See Notes 1, 2, 3</i>	7/16" <i>See Notes 1, 2, 3</i>	15/32" <i>See Notes 1, 3</i>	15/32" <i>See Notes 1, 3</i>	<i>Common Nails Not an Option</i>	N/A

**Notes:**

1. Local building code requirements for sheathing thickness and/or nail size/attachment spacing may be more stringent based on site conditions.
2. For concrete and clay tile roof covers, minimum required sheathing thickness is 15/32".
3. For metal roof covers, verify manufacturer's sheathing thickness requirements are met.
4. Full round head Ø; No clipped-head nails, common nails or staples shall be allowed. Refer to figure 1.

**FIGURE 1**

**APPLICABLE STANDARDS:** FORTIFIED HOME™ - IBC F-1910-2 (2020)

**DESCRIPTION:** HIGH WIND - NEW CONSTRUCTION ROOF DECK ATTACHMENT - STRUCTURAL WOOD PANELS

**DRAWING #:** F-RS-3

**DATE:** 10/07/2020

**F-RS-3**

## 4.3 Inspection and Attachment of Existing Roof Deck (Re-Roof) Only

- Existing roof deck must be inspected (after old roofing materials have been removed) to identify any damaged or deteriorated decking. Replace damaged decking in accordance with FORTIFIED Standard Detail [F-RR-1](#) “Re-Roofing Deck Replacement Fastening Detail” (refer to Appendix A).
  - Damage includes (but is not limited to) soft or spongy wood, wood swelling or buckling, delaminating (plywood) or crumbling/flaking of wood.
  - Do not cut or notch supporting wood members when removing damaged/deteriorated decking.
  - If a section of the roof deck is damaged or deteriorated, removed and replace the entire damaged sheet or board.

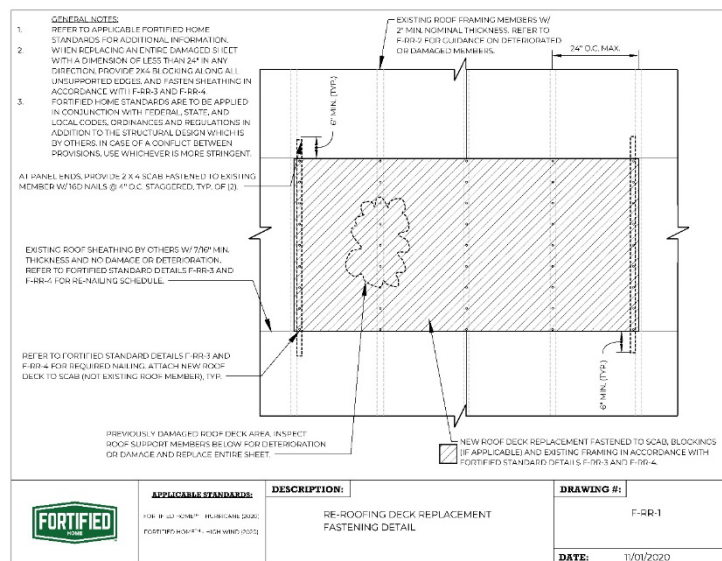

**F-RR-1**

- Existing wood roof framing members (rafters or truss top chords) below damaged/deteriorated decking must be inspected for damage/deterioration.
- Damaged/Deteriorated roof framing members may be repaired in accordance with FORTIFIED Standard Detail [F-RR-2](#) “Re-Roofing New Scab Member Detail for Damaged or Deteriorated Wood Framing Member” (refer to Appendix A) if all the following conditions are met:
  - Roof framing members are 2x (nominal 2 in. thick) lumber spaced 24 in. O.C. maximum.
  - Damaged/deteriorated area must be less than 25% of roof framing member depth.
  - Damaged/deteriorated area must not exceed 25% of member length up to a maximum length of 2 ft.
  - Damaged/deteriorated area must be a minimum of 6 in. away from any mechanical connections (i.e., truss/rafter hangers, truss connector plates, etc.).

NEW ROOF

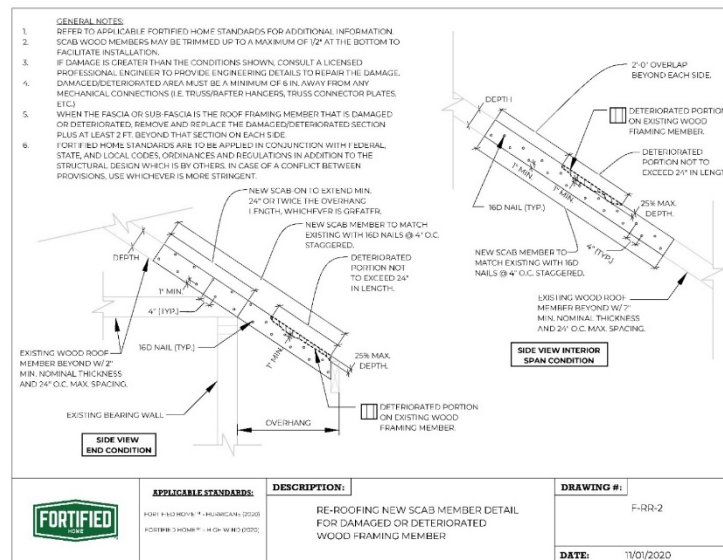

**F-RR-2**

- For conditions other than described above, roof members must be evaluated by a licensed professional engineer to verify structural capacity and/or provide a design for repair.
- For sawn lumber or wood board roof decking, add fasteners as required to meet the requirements of FORTIFIED Standard Detail **F-RS-1** “Roof Deck Attachment – Sawn Lumber or Wood Board Roof Deck With No Gaps” (refer to Appendix A).
- For wood structural panel roof sheathing, re-nail the roof deck in accordance with the following (refer to Appendix A for FORTIFIED Standard Details):

NEW ROOF

**For Hurricane designation: F-RR-3 “Hurricane – Re-nailing the Roof Deck (Wood Structural Panels)”**

- Refer to [section 4.1](#) for roof deck minimum thickness requirements.
- If it can be documented that existing nailing meets the requirements of Table **F-RS-2** (refer to [section 4.2.2](#)), then supplemental fastening is not required.
- If supplemental fastening is required, then additional 0.113-in. x 2<sup>3</sup>/<sub>8</sub>-in. 8d ring-shank nails (refer to [section 2.6](#)) are required to be installed at 4 in. O.C.
- Spacing between new and existing nails shall not be less than 2 in. O.C.
- To avoid wood splitting, stagger nails for spacings 3 in. O.C. or less.

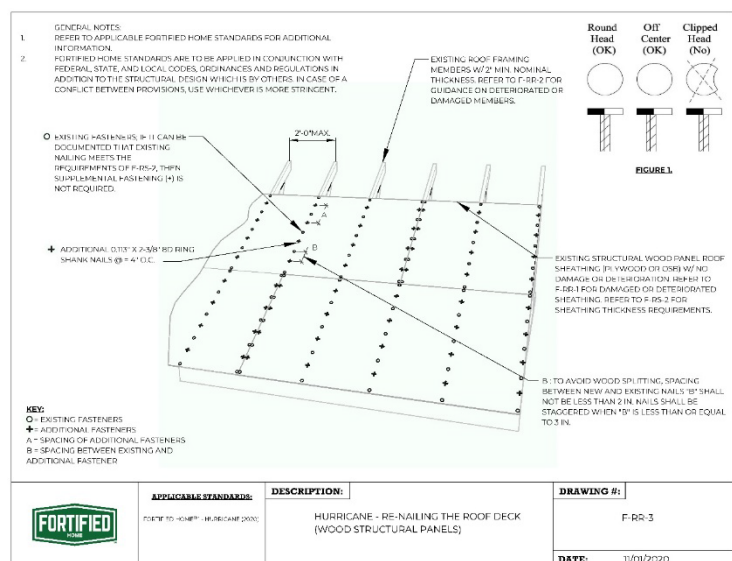

**F-RR-3**



**For High Wind designation: F-RR-4 “High Wind – Re-nailing the Roof Deck (Wood Structural Panels)”**

- Refer to [section 4.1](#) for roof deck minimum thickness requirements.
- If it can be documented that existing nailing meets the requirements of Table **F-RS-3** (refer to [section 4.2.2](#)), then supplemental fastening is not required.
- If supplemental fastening is required, then additional 0.113-in. x 2<sup>3</sup>/<sub>8</sub>-in. 8d ring-shank nails (refer to [section 2.6](#)) are required to be installed at 6 in. O.C.
- Spacing between new and existing nails shall not be less than 2 in. O.C.
- To avoid wood splitting, stagger nails for spacings 3 in. O.C. or less

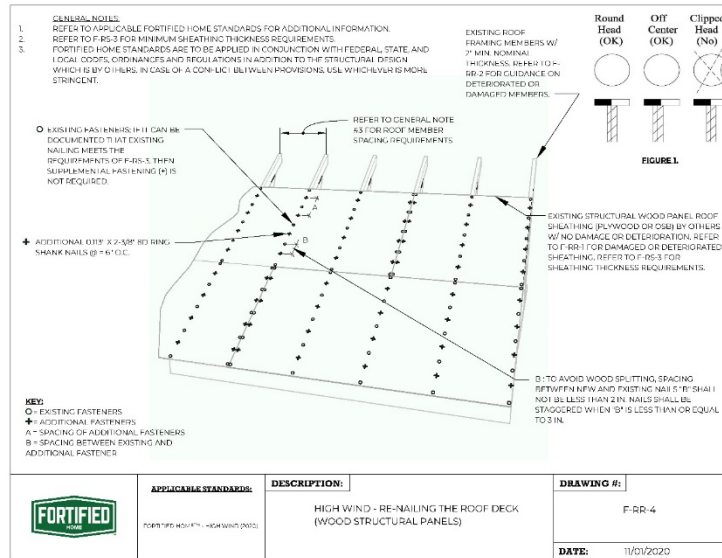

**F-RR-4**

## 4.4 Sealing the Roof Deck (roof slopes 2:12 or greater)

**NOTE:** For roof slopes less than 2:12, low-slope roof cover system that meets required site design uplift pressures shall be installed in accordance with manufacturer installation instructions.

- Roof slope is 2:12 or greater.
- Use corrosion-resistant fasteners in accordance with FORTIFIED Standard Detail [F-G-1](#) “Corrosion Protection Requirements” (refer to Appendix A).

### 4.4.1 Sealing the Roof Deck for Shingle and Metal Roof Covers

For **shingle or metal roof covers**, seal the roof deck in accordance with **one** of the following three methods (refer to Appendix A for FORTIFIED Standard Details):

### 4.4.1.1 Method 1 (for shingles and metal): **F-SRD-2** “Sealed Roof Deck – Flashing Tape and Underlayment – Shingle or Metal Roof Covers – Steep Slope”

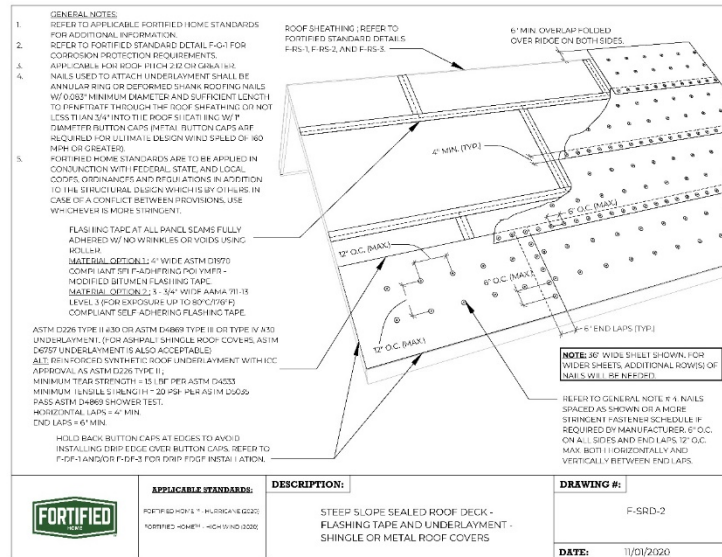

### **F-SRD-2**

#### **Tape Types and Installation:**

Tape seams between roof sheathing that forms the roof deck. There are two material options for taping the seams on the roof deck:

- Material Option 1:** Apply an ASTM D1970 compliant self-adhering polymer-modified bitumen flashing tape, at least 4 in. wide, directly to the roof deck to seal the horizontal and vertical joints in the roof deck.
- Material Option 2:** Apply an AAMA 711-13, Level 3 (for exposure up to 80°C/176°F) compliant self-adhering flexible flashing tape at least 3 3/4 in. wide directly to the roof deck to seal the horizontal and vertical joints in the roof deck.

Any flashing tape used to achieve a sealed roof deck must be fully adhered without voids (e.g., wrinkles) in order to be accepted. In some instances, the ability of self-adhered flashing tapes to adhere to oriented strand board (OSB) sheathing may be compromised by the level of surface texture or wax used in fabricating the OSB panels. In applications where, flashing tape adhesion to OSB is marginal, apply a manufacturer-specified compatible primer to the OSB panels where the tape will be applied to ensure the proper attachment of the self-adhering tape to the sheathing. Do not nail or staple the tape to the roof sheathing. Refer to the manufacturer’s recommendations for installation and primer requirements (if applicable).

NEW ROOF

### ***Underlayment Types:***

Next, apply one of the following code-compliant underlayment options over the self-adhering tape:

- ASTM D226 Type II (#30)
- ASTM D4869 Type III or Type IV (#30)
- ASTM D6757 (for asphalt shingle roof covers)
- As an alternative, apply a reinforced synthetic roof underlayment which has an ICC approval as an alternate to ASTM D226 Type II felt paper. The synthetic underlayment must have a minimum tear strength of 15 lbf in accordance with ASTM D4533 and a minimum tensile strength of 20 lbf/in. in accordance with ASTM D5035.
- CAUTION:** *Be sure to check product labelling carefully. Not all products labelled ASTM D4869 are Type III or Type IV. Look for ASTM D4869 felt that is labeled Type III or Type IV. ASTM D4869 Type I or Type II will NOT be accepted.*

**NOTE:** An AC266-rated system consisting of wood structural panel sheathing with integrated water resistive barrier such as *Huber Zip*™ roof sheathing used in combination with approved or proprietary tape to seal the roof deck seams as described above and in compliance with manufacturers installation instructions, is deemed to comply as an approved FORTIFIED sealed roof deck without any additional underlayments required.

### ***Underlayment Installation:***

Underlayment must be attached using annular-ring or deformed-shank roofing nails (0.083 in. minimum diameter and sufficient length to penetrate through the roof sheathing or not less than  $\frac{3}{4}$  in. into the roof sheathing) with minimum 1-in.-diameter caps (metal or plastic button cap nails). Metal caps and nail or metal cap-nails are required for ultimate design wind speed of 160 mph or greater. Fasteners shall meet the corrosion protection requirements outlined in [F-G-1](#).

Space fasteners at 6 in. O.C. spacing along all laps and at 12 in. O.C. vertically and horizontally in the field or a more stringent fastener schedule if required by the manufacturer for high-wind and prolonged exposure installations. Horizontal laps must be a minimum of 4 in. and end laps must be a minimum of 6 in.

### 4.4.1.2 Method 2 (for shingles and metal): **F-SRD-3** “Sealed Roof Deck – Two Layers Felt Underlayment – Shingle or Metal Roof Covers, Steep Slope”

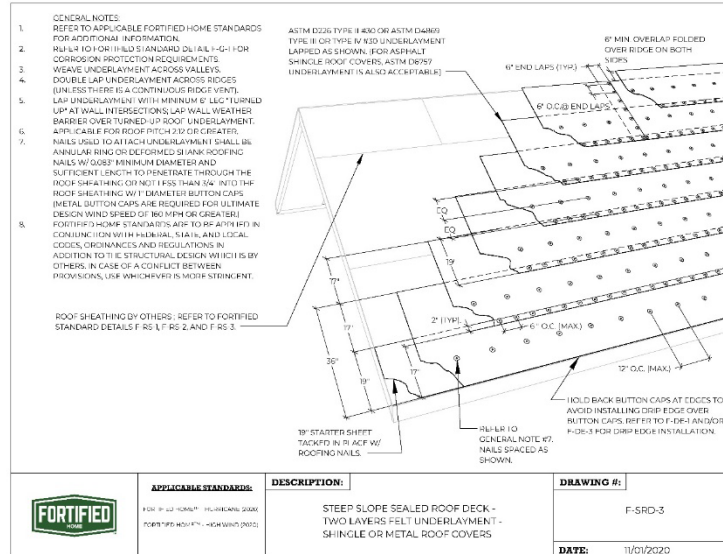

**F-SRD-3**

NEW ROOF

#### **Underlayment Types:**

Apply (2) layers of one of the following code-compliant underlayment options:

- ASTM D226 Type II (#30)
- ASTM D4869 Type III or Type IV (#30)
- ASTM D6757 (for asphalt shingle roof covers)
- CAUTION:** Be sure to check product labelling carefully. Not all products labelled ASTM D4869 are Type III or Type IV. Look for ASTM D4869 felt that is labeled Type III or Type IV. ASTM D4869 Type I or Type II will NOT be accepted.

#### **Underlayment Installation:**

Install two (2) layers of underlayment in a shingle-fashion, lapped 19 in. on horizontal seams (36-in. roll), and 6 in. on vertical seams.

The starter course of felt is to be installed as described below and shown in **F-SRD-3**. Cut 17 in. off one side of the roll and install the remaining 19-in.-wide strip of underlayment along the eave, safely tacked in place. Carefully install a 36-in.-wide roll of underlayment over the 19-in.-wide course of underlayment along the eave. Follow the same procedure for each course, overlapping the sheets 19 in. (leaving a 17 in. exposure).

Underlayment must be attached using annular-ring or deformed-shank roofing nails (0.083 in. minimum diameter and sufficient length to penetrate through the roof sheathing or not less than 3/4 in. into the roof sheathing) with minimum 1-in.-diameter caps (metal or plastic button cap nails). Metal caps and

nail or metal cap-nails are required for ultimate design wind speed of 160 mph or greater. Fasteners shall meet the corrosion protection requirements outlined in [F-G-1](#).

Fasten the bottom edge of the roll (horizontal lap) with fasteners at 6 in. O.C. Since the bottom edge (horizontal lap) of the next layer of underlayment will be fastened approximately 19 in. above the horizontal lap below, install a row of nails with 12 in. O.C. horizontal spacing about 10 in. above the bottom lap. When the installation is completed, the resulting fastening of the two (2) layers of felt should consist of the same fasteners at approximately 6 in. O.C. along all laps and at not more than 12 in. O.C. in the field of the sheet between the side laps. Add fasteners along any exposed vertical laps so that the maximum spacing between fasteners is 6 in. O.C.

#### 4.4.1.3 Method 3 (for shingles and metal): [F-SRD-4](#) “Sealed Roof Deck – Self-Adhered Membrane (Showing Bond Break for Asphalt Shingles) – Shingle and Metal Roof Covers – Steep Slope”

**CAUTION:** *Manufacturers emphasize the need for adequate attic ventilation when self-adhered membrane is applied over the entire roof. This is particularly important north of the North Carolina/South Carolina border. Also, some local building departments prohibit the use of this system. Check with the local building department for restrictions and refer to underlayment and primary roof system manufacturer’s installation instructions for ventilation limitations.*

NEW ROOF

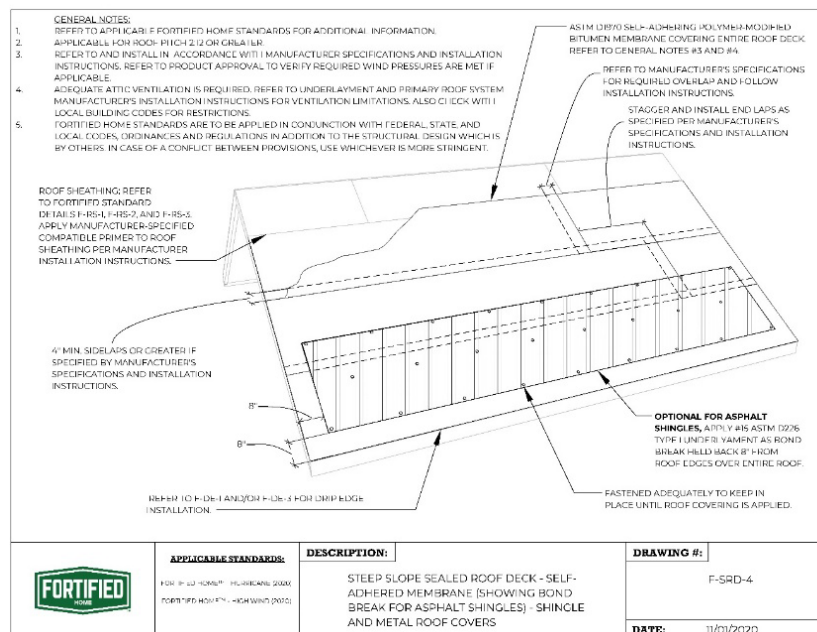

**[F-SRD-4](#)**

***Underlayment Type:***

ASTM D1970 self-adhering polymer-modified bitumen membrane.

***Underlayment Installation:***

Refer to and install in accordance with manufacturer specifications and installation instructions. Refer to product approval to verify required wind pressures are met, if applicable.

Cover the entire roof deck with a full layer of self-adhering polymer-modified bitumen membrane meeting ASTM D1970 requirements. Lap underlayment with minimum 6-in. leg “turned up” at wall intersections. Lap wall weather barrier over turned-up roof underlayment.

In some instances, the ability of the self-adhered membranes to adhere to oriented strand board (OSB) sheathing may be compromised by the level of surface texture or wax used in fabricating the OSB panels. In applications where membrane adhesion to OSB is marginal, apply a manufacturer-specified compatible primer to the OSB panels to ensure the proper attachment of the self-adhering membrane to the sheathing.

***Bond Break and Installation:***

Shingles may bond to self-adhered membranes which could lead to damage of the sheathing when it comes time to replace the shingles. Consequently, for shingle roofs only, the membrane should be covered with a bond break such as a #15 ASTM D226, Type I underlayment. The bond break only needs to be fastened well enough to keep it on the roof surface and provide safety to the roofers until the shingles are applied. Hold bond break material back 8 in. from roof edges to allow mastic and starter strip or self-adhered starter strip to be applied directly to drip edge.





to oriented strand board (OSB) sheathing may be compromised by the level of surface texture or wax used in fabricating the OSB panels. In applications where, flashing tape adhesion to OSB is marginal, apply a manufacturer-specified compatible primer to the OSB panels where the tape will be applied to ensure the proper attachment of the self-adhering tape to the sheathing. Do not nail or staple the tape to the roof sheathing. Refer to the manufacturer's recommendations for installation and primer requirements (if applicable).

### ***Anchor Sheet Underlayment Type:***

Next, apply the following underlayment over the self-adhering tape:

- ASTM D226 Type II (#30)

**NOTE:** An AC266-rated system consisting of wood structural panel sheathing with integrated water resistive barrier such as *Huber Zip*™ roof sheathing used in combination with approved or proprietary tape to seal the roof deck seams as described above and in compliance with manufacturers installation instructions, is deemed to comply as an approved FORTIFIED sealed roof deck without any additional underlayments required. To consider this system as an anchor sheet for concrete and clay tile roof covers, the system must meet required site design uplift pressures and installation must be in compliance with manufacturer installation instructions and FRSA/TRI Florida High Wind Concrete and Clay Tile Installation Manual.

### ***Anchor Sheet Installation:***

Refer to and install in accordance with FRSA/TRI Florida High Wind Tile Installation Manual, Revised 5<sup>th</sup> Edition (for ASCE 7-10) or 6<sup>th</sup> Edition (for ASCE 7-16). Refer to product approval to verify required wind pressures are met if applicable.

Anchor sheet must be attached using annular-ring or deformed-shank roofing nails (0.083 in. minimum diameter and sufficient length to penetrate through the roof sheathing or not less than  $\frac{3}{4}$  in. into the roof sheathing) with minimum 1-in.-diameter caps (metal or plastic button cap nails). Metal caps and nail or metal cap-nails are required for ultimate design wind speed of 160 mph or greater. Fasteners shall meet the corrosion protection requirements outlined in [F-G-1](#).

Space fasteners at 6 in. O.C. spacing along all laps and at 12 in. O.C. vertically and horizontally in the field or a more stringent fastener schedule if required by the manufacturer for high-wind and prolonged exposure installations. Horizontal laps must be a minimum of 4 in. and end laps must be a minimum of 6 in.

### ***Roof Tile Cap Sheet Type and Installation:***

Finally, apply an approved self-adhering polymer-modified bitumen roof tile cap sheet complying with ASTM D1970 that meets the site design wind speeds over anchor sheet OR hot-mop an approved tile underlayment over the underlayment/anchor sheet using hot asphalt.

Refer to and install in accordance with FRSA/TRI Florida High Wind Tile Installation Manual, Revised 5<sup>th</sup> Edition (for ASCE 7-10) or 6<sup>th</sup> Edition (for ASCE 7-16). Refer to product approval to verify required wind pressures are met if applicable.

#### 4.4.2.2 Method 2 (for tile): **F-SRD-6** “Sealed Roof Deck – Self-Adhered Membrane – Concrete and Clay Tile Roof Covers, Steep Slope”

**CAUTION:** *Manufacturers emphasize the need for adequate attic ventilation when self-adhered membrane is applied over the entire roof. This is particularly important north of the North Carolina/South Carolina border. Also, some local building departments prohibit the use of this system. Check with the local building department for restrictions and refer to underlayment and primary roof system manufacturer’s installation instructions for ventilation limitations.*

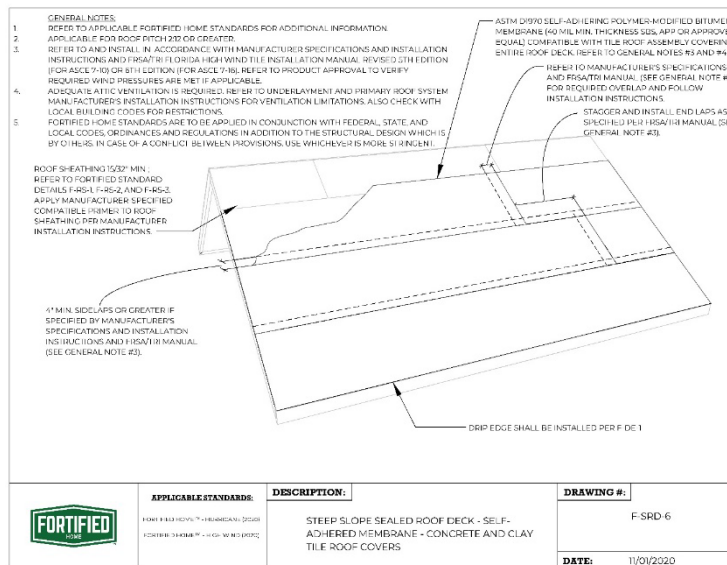

NEW ROOF

### **F-SRD-6**

#### **Underlayment Type:**

ASTM D1970 self-adhering polymer-modified bitumen membrane; 40 mil minimum thickness, SBS, APP or approved equal is required per FRSA/TRI Florida High Wind Tile Installation Manual.

#### **Underlayment Installation:**

Refer to and install in accordance with FRSA/TRI Florida High Wind Tile Installation Manual, Revised 5<sup>th</sup> Edition (for ASCE 7-10) or 6<sup>th</sup> Edition (for ASCE 7-16). Refer to product approval to verify required wind pressures are met, if applicable.

Cover the entire roof deck with a full layer of self-adhering polymer-modified bitumen membrane meeting ASTM D1970 requirements. Lap underlayment with minimum 6-in. leg “turned up” at wall intersections. Lap wall weather barrier over turned-up roof underlayment.

In some instances, the ability of the self-adhered membranes to adhere to oriented strand board (OSB) sheathing may be compromised by the level of surface texture or wax used in fabricating the OSB panels. In applications where membrane adhesion to OSB is marginal, apply a manufacturer-specified compatible primer to the OSB panels to ensure the proper attachment of the self-adhering membrane to the sheathing.

## 4.5 Drip Edge (roof slopes 2:12 or greater)

**NOTE:** For roof slopes less than 2:12, refer to manufacturer’s drip edge installation requirements.

- Use new (minimum 26 gauge for steel) corrosion-resistant metal drip edge and fasteners in accordance with FORTIFIED Standard Detail **F-G-1** “Corrosion Protection Requirement” (refer to Appendix A).
  - Drip edge shall comply with building code requirements for metal flashing. For additional guidance, refer to the [FORTIFIED Home General Flashing Guidelines for Steep-Sloped Roofs](#).
- For shingle or metal roof covers with sealed roof decks in accordance with **F-SRD-2**, **F-SRD-3** or **F-SRD-4** (refer to [section 4.4](#)), install drip edge along all eaves and gable rake edges in accordance with the following FORTIFIED Standard Details:

NEW ROOF

**For Hurricane designation: [F-DE-1](#) “Hurricane – Drip Edge Installation Over Underlayment”**

**GENERAL NOTES:**

- REFER TO APPLICABLE FORTIFIED HOME STANDARDS FOR ADDITIONAL INFORMATION. REFER TO FORTIFIED STANDARD DETAIL F-G-1 FOR CORROSION PROTECTION REQUIREMENTS.
- PRIME SURFACES TO SEAL THE DRIP EDGE.
- SHINGLE EDGE COVERS SEAL THE DRIP EDGE, UNDERLAYMENT AND STARTER STRIP AT THE EDGE BY SEAMING WITH A SELF-ADHERING STARTER STRIP OR APPLYING AN 8" WIDE LAYER OF COMPATIBLE FLASHING CEMENT WITH 100% MAX THICKNESS OVER THE DRIP EDGE AND UNDERLAYMENT.
- FOR METAL ROOF COVERS, APPLY A COMPATIBLE MANUFACTURER-APPROVED SEALANT BETWEEN THE DRIP EDGE AND ADJACENT UNDERLAYMENT TO PREVENT WATER FROM ACCUMULATING UNDER THE DRIP EDGE OR USE A MANUFACTURER-APPROVED SELF-ADHERED SEAM TAPE. APPLICABLE FOR ROOF PITCH 12:12 OR GREATER. FOR ROOF SLOPES LESS THAN 12:12, REFER TO MANUFACTURER'S DRIP EDGE INSTALLATION REQUIREMENTS.
- FORTIFIED HOME STANDARDS ARE TO BE APPLIED IN CONJUNCTION WITH FEDERAL, STATE, AND LOCAL CODES, ORDINANCES AND REGULATIONS IN ADDITION TO THE STRUCTURAL DESIGN WHICH IS BY OTHERS. IN CASE OF A CONFLICT BETWEEN PROVISIONS, USE WHICHEVER IS MORE STRINGENT.

METAL DRIP EDGE (MINIMUM 26 GAUGE FOR STEEL) ALONG ALL EAVES AND GABLE RAKE EDGES INSTALLED OVER UNDERLAYMENT. MAKE SURE THE TOP SURFACE OF THE DRIP EDGE IS CLEAN, FREE OF OIL, AND IF REQUIRED BY THE STARTER STRIP MANUFACTURER, PRIME WITH ASTM D41 PRIMER FOR SEALING THE DRIP EDGE REFER TO GENERAL NOTE #3.

UNDERLAYMENT INSTALLED IN ACCORDANCE WITH FORTIFIED STANDARD DETAILS F-SRD-2, F-SRD-3, F-SRD-4, OR F-SRD-5.

2" MIN.

2" MIN. OVERLAP

2" O.C. MAX STAGGERED

1/2" MIN.

DRIP EDGE FLANGE SHALL EXTEND 1/2" MIN. BELOW SHEATHING

	<b>APPLICABLE STANDARDS:</b> FORTIFIED HOME™ HURRICANE-2008	<b>DESCRIPTION:</b> HURRICANE - DRIP EDGE INSTALLATION OVER UNDERLAYMENT	<b>DRAWING #:</b> F-DE-1
			<b>DATE:</b> 11/01/2020

**[F-DE-1](#)**

**For High Wind designation: F-DE-3 “High Wind – Drip Edge Installation Over Underlayment”**

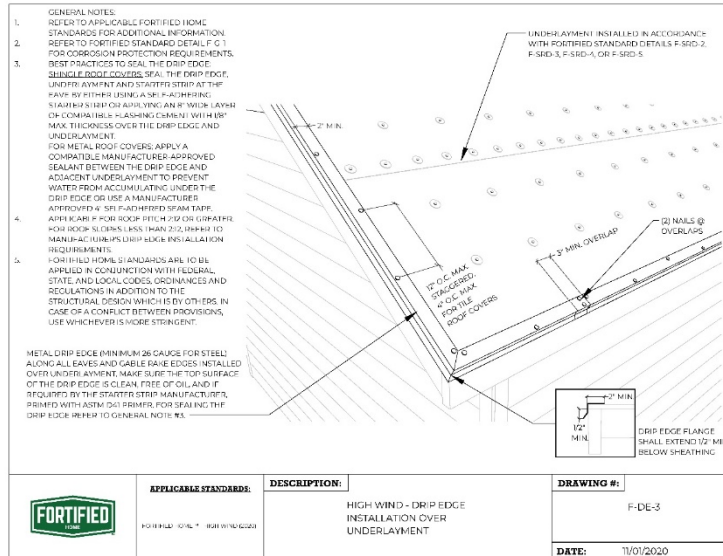

**F-DE-3**

NEW ROOF

**Installation and Attachment**

Drip edges shall be installed OVER the underlayment along gable rake edges and at eaves. Overlap drip edge a minimum of 3 in. at joints. Drip edge flange shall extend 1/2 in. below the bottom of the sheathing and extend back on the roof a minimum of 2 in.

Install (2) fasteners installed in each overlap joint. Mechanical fasteners should be applied in an alternating (staggered) pattern along the length of the drip edge with adjacent fasteners placed near opposite edges of the leg/flange of drip edge on the roof. Drip edges must be mechanically fastened to the roof deck at the following maximum spacing:

**For Hurricane designation: 4 in O.C.**

**For High Wind designation: 12 in. O.C. (EXCEPTION: 4 in. O.C. max. for tile roof covers)**

**Sealing the Drip Edge**

For shingle roof covers: The top surface of the drip edge shall be clean, free of oil, and if required by the starter strip manufacturer, primed with ASTM D41 primer. Seal the drip edge, underlayment and starter strip at the eave by either using a self-adhering starter strip or applying an 8-in.-wide layer of compatible flashing cement with 1/8 in. maximum thickness over the drip edge and underlayment.

For metal roof covers: The top surface of the drip edge shall be clean, free of oil, and if required, primed with manufacturer-approved primer. Apply a compatible manufacturer-approved sealant between the drip edge and adjacent underlayment to prevent water from accumulating under the drip edge or use a manufacturer approved 4 in. self-adhered seam tape.

- For concrete and clay tile roof covers with sealed roof decks in accordance with **F-SRD-5** or **F-SRD-6** (refer to [section 4.4](#)), install drip edge along all eaves and gable rake edges in accordance with FORTIFIED Standard Detail [F-DE-1](#).

## 4.6 Flashing

Flashings are used to weatherproof or seal roof system edges at perimeters, penetrations, walls, expansion joints, valleys, drains, and other places where the roof covering is interrupted or terminated. Ensuring FORTIFIED Roof requirements are in place, roofing contractors shall install flashings whether metal or membrane type in a manner consistent with roof cover manufacturers installation requirements preventing moisture from entering the wall or roof, or through moisture-permeable materials at intersections or other penetrations through the roof plane.

- Use new, corrosion-resistant metal flashing and fasteners in accordance with FORTIFIED Standard Detail [F-G-1](#), “Corrosion Protection Requirements” (refer to Appendix A).
  - ALL FLASHING MUST BE IN NEW CONDITION.
  - When re-roofing, all existing flashing material shall be removed and discarded.
  - For additional guidance, refer to the [FORTIFIED Home General Flashing Guidelines for Steep-Sloped Roofs](#).
- Flashings shall be installed at all places where the roof covering is interrupted or terminated, including, but not limited to the following:
  - Roof system perimeters and edges
  - Roof pitch changes
  - Roof penetrations
  - Walls
  - Chimneys
  - Expansion joints
  - Valleys
  - Drains
- Flashings shall be installed in accordance with the most restrictive of the following compliance methods:
  - Local building code requirements
  - Product manufacturer’s installation instructions
  - Additional roof cover specific supplemental standards listed below:

*(Also listed in [Appendix C](#))*

For asphalt shingle roof covers:

- [Asphalt Roofing Manufacturers Association \(ARMA\) Residential Asphalt Roofing Manual](#)
- [National Roofing Contractors Association \(NRCA\) Roofing Manual: Architectural Metal Flashing](#)



- [2017 Florida Building Code \(FBC\) Roofing Application Standard \(RAS\) No. 115 “Standard Procedures for Asphalt Shingle Installation” listed in the Test Protocols for High Velocity Hurricane Zones](#)
- [2014 Florida Building Code \(FBC\) Roofing Application Standard \(RAS\) No. 115 “Standard Procedures for Asphalt Shingle Installation” listed in the Test Protocols for High Velocity Hurricane Zones](#)

For concrete and clay tile roof covers:

- [Florida Roofing and Sheet Metal Contractors Association \(FRSA\)/Tile Roof Institute \(TRI\) Florida High Wind Concrete and Clay Tile Installation Manual, Fifth Edition \(for ASCE 7-10\) or Sixth Edition \(for ASCE 7-16\)](#)
- [2017 Florida Building Code \(FBC\) Roofing Application Standard \(RAS\) No. 111, 118, 119, or 120 listed in the Test Protocols for High-Velocity Hurricane Zones](#)
- [2014 Florida Building Code \(FBC\) Roofing Application Standard \(RAS\) No. 111, 118, 119, or 120 listed in the Test Protocols for High-Velocity Hurricane Zones](#)

Additionally, for wood shingles and wood shakes:

- [Cedar Shake and Shingle Bureau \(CSSB\) New Roof Construction Manual](#)

## 4.7 Steep-Slope (2:12 and greater) Roof Coverings Only

- Roof slope must be 2:12 or greater.
- All roof coverings and their attachments must comply with one of the following as applicable for roof cover type:
  - ASCE 7 design wind speed for the site location of the building and must be installed in accordance with the manufacturer’s recommendations for high-wind regions.
    - Minimum 130 MPH ultimate design wind speed (refer to [section 2.10](#) for “ultimate” vs. “nominal” wind speed)
    - Minimum Exposure Category C
  - Per 2015 IRC R905.1 shall be installed to resist the component and cladding loads specified in Table R301.2(2), adjusted for height and exposure in accordance with Table R301.2(3).
    - Minimum 130 MPH ultimate design wind speed (refer to [section 2.10](#) for “ultimate” vs. “nominal” wind speed)
    - Minimum Exposure Category C
    - Refer to the appropriate FORTIFIED Design Pressure Calculator on the [FORTIFIED website](#) for guidance on required design pressures for steep-slope roof coverings

#### 4.7.1 For Asphalt Shingles Only (Steep Slope):

- Asphalt shingles must meet ASTM D3161 (Class F) or ASTM D7158 (Class H)

For **FORTIFIED Hail Supplement** requirements, refer to [section 7.2.1](#).

- Asphalt shingles must be installed per manufacturer recommendations for high wind regions or local building code requirements, whichever is more stringent.
- Installation of starter strips at eaves shall be in accordance with one of the following two options (refer to Appendix A for FORTIFIED Standard Details):
  - **Option 1: F-RC-1** “Asphalt Shingle Installation Guidance for Steep Slope – Option 1: Peel and Stick Starter Strip Installation at Eave or Rake”
  - **Option 2: F-RC-2** “Asphalt Shingle Installation Guidance for Steep Slope – Option 2: Shingle Strip Starter Installation at Eave or Rake”
- Installation of shingles at gable rakes shall be in accordance with one of the following three options (refer to Appendix A for FORTIFIED Standard Details):
  - **Option 1: F-RC-1** “Asphalt Shingle Installation Guidance for Steep Slope – Option 1: Peel and Stick Starter Strip Installation at Eave or Rake”
  - **Option 2: F-RC-2** “Asphalt Shingle Installation Guidance for Steep Slope – Option 2: Shingle Strip Starter Installation at Eave or Rake”
  - **Option 3: F-RC-3** “Asphalt Shingle Installation Guidance for Steep Slope – Option 3: Shingle Set Directly in Flashing Cement at Rake Only”

See details pictured on pages 45–46

- At intersections and both sides of open valleys, shingles shall be set in a minimum 8-in.-wide strip of flashing cement (maximum thickness of flashing cement =  $\frac{1}{8}$  in.).
- At cut side of closed valleys, shingles shall be set in a minimum 2-in.-wide strip of flashing cement (maximum thickness of flashing cement =  $\frac{1}{8}$  in.).
- Woven valleys shall be installed per manufacturer specifications.

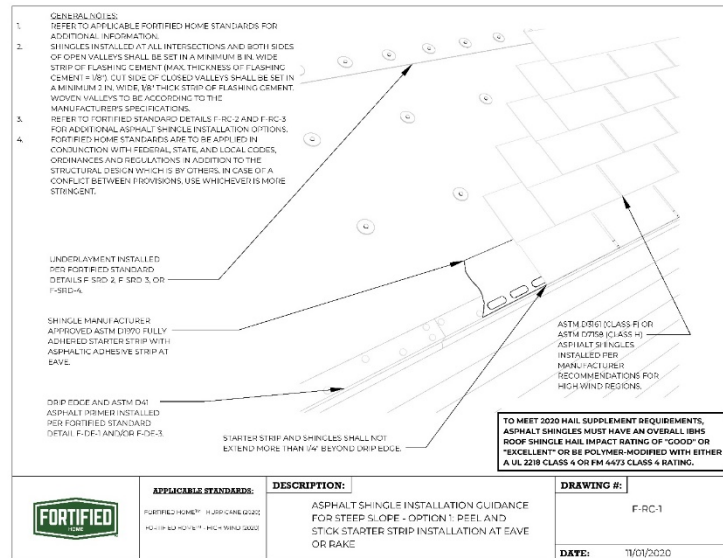

**F-RC-1**

**F-RC-1 - Self-Adhered Starter Strip Installation at Eave or Rake**

Apply shingle manufacturer-approved ASTM D1970 fully adhered (peel-and-stick) starter strip with asphaltic adhesive strip at eave—installed so that starter strip adheres to and covers the drip edge top surface. Starter strip and shingles must not extend more than 1/4 in. beyond the drip edge.

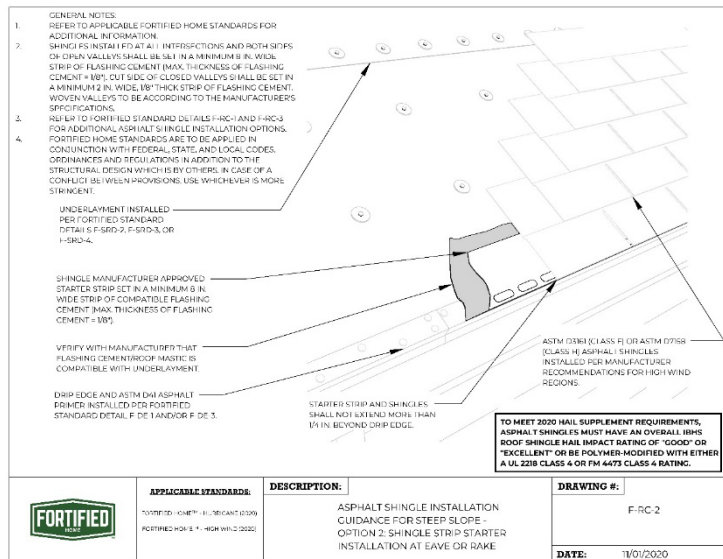

**F-RC-2**

**F-RC-2 - Single Strip Starter Installation at Eave or Rake** Set shingles in a minimum 8-in.-wide strip of compatible flashing cement. Maximum thickness of flashing cement shall be 1/8 in. Fasten starter strips parallel to the eaves along a line above the eave line according to the manufacturer's specifications. Position fasteners to ensure they will not be exposed under the cutouts in the first course. Starter strips and shingles must not extend more than 1/4 in. beyond the drip edge.

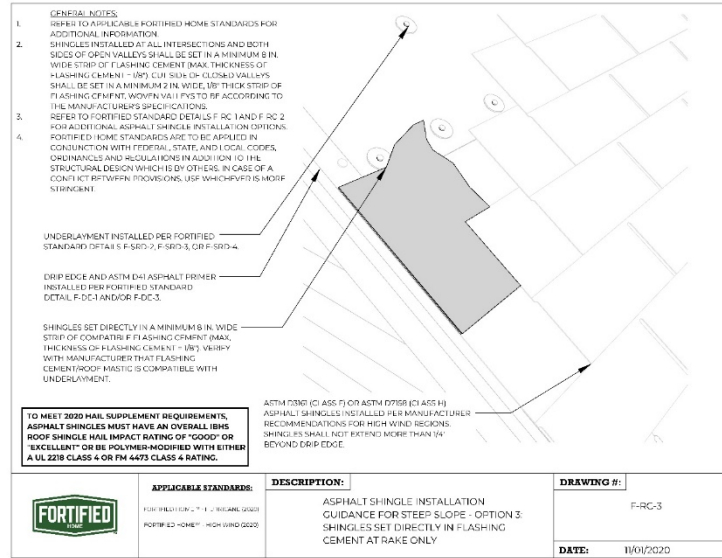

**F-RC-3**

**F-RC-3 - Shingles Set Directly in Flashing Cement at Rake Only**

Each shingles course at rakes shall be set in a minimum 8-in.-wide strip of compatible flashing cement. Maximum thickness of flashing shall be 1/8 in. Fasten shingles at rakes according to the manufacturer's specifications. Shingles must not extend more than 1/4 in. beyond the drip edge.

NEW ROOF

#### 4.7.2 For Clay and Concrete Tile Only (Steep Slope)

- Clay and concrete roof tile systems must have a certified design pressure report meeting the requirements outlined in [section 2.8.1](#).
- Clay and concrete roof tile systems and attachments must have design pressure ratings equal to or greater than the required wind uplift pressures for the site design wind speed, roof height, exposure category, and location on the building corresponding to no less than  $V_{ult} = 130$  mph (Refer to [section 2.10](#) for “ultimate” vs. “nominal” wind speed) and Exposure C (refer to [Appendix D](#) for definition).
- Installation including flashings must be in accordance with the following:
  - Manufacturer’s installation instructions
  - Manufacturer’s product approval
  - [FRSA/TRI Florida High Wind Concrete and Clay Tile Installation Manual Fifth Edition \(for ASCE 7-10\)](#) or Sixth Edition (for ASCE 7-16)
- Roof tiles may be installed with roof tile adhesives that are recognized and installed in accordance with one of the following:
  - ICC-ES Evaluation Report
  - Florida Product Approval
  - Miami-Dade County Notice of Acceptance (NOA)
  - Texas Department of Insurance (TDI) Evaluation Report
- Mortar-set tile or mortar-set hip and ridge tiles are not permitted.
- Hip and ridge boards or metal must be attached to the roof framing to resist the uplift pressure for the site design wind speed and exposure or in accordance with the tile manufacturer’s product approval.
- Hip and ridge tiles must be secured to the hip and ridge boards or metal with mechanical fasteners and/or an approved roof tile adhesive to resist the uplift pressure for the site design wind speed and exposure or in accordance with the tile manufacturer’s product approval.
- Installation must be over continuous decking meeting minimum thickness requirements and one of the acceptable sealed roof deck underlayment options per [section 4.4](#).

**For FORTIFIED Hail Supplement requirements, refer to [section 7.2.2](#).**

### 4.7.3 For Metal Shingles and Panels Only (Steep Slope)

- Metal roof cover systems must have a certified design pressure report meeting the requirements outlined in [section 2.8.1](#):
  - Roof cover systems described as “pressure-rated” or “DP-rated” in this FORTIFIED Standard must have a certified design pressure report in compliance with one of the following, have DP ratings that meet or exceed site-specific required design pressures corresponding to a minimum of  $V_{ult} = 130$  mph and Exposure C, and must be installed in accordance with the manufacturer’s instructions:
    - ✓ ICC-ES Evaluation Report
    - ✓ Florida Product Approval
    - ✓ Miami-Dade County Notice of Acceptance (NOA)
    - ✓ Texas Department of Insurance (TDI) Evaluation Report
  - DP ratings from organizations not listed above must incorporate a 2.0 safety factor by testing in accordance with **UL 580** or **UL 1897** or **TAS 125**.
    - UL 580 test report (with safety factor of 2.0) is acceptable for design uplift pressures **up to 52.5 psf maximum**.
    - For design uplift pressures greater than 52.5 psf, a UL 1897 test report (with safety factor of 2.0) will be required with design pressure ratings greater than or equal to the required design uplift pressures.
  - FORTIFIED will not accept engineering extrapolation of test data (outside of the parameters set by the report/approval) to achieve greater DP ratings or larger connection spacings than listed in the certified report. Additionally, the installed product must match the tested assembly in the certified report.
  - Refer to the appropriate FORTIFIED Design Pressure Calculator on the [FORTIFIED website](#) for guidance on required design pressures for steep-slope roof coverings.
- Installation must be in accordance with manufacturer specifications for the applicable uplift pressures.
- Installation must be over continuous decking meeting minimum thickness requirements and one of the acceptable sealed roof deck underlayment options per [section 4.4](#).
- Flashings must be installed in accordance with the manufacturer’s installation instructions.

NEW ROOF

**For FORTIFIED Hail Supplement** requirements, refer to [section 7.2.3](#).

### 4.7.4 For Other Steep-Slope Roof Coverings

- Roof cover systems must have either a certified design pressure report meeting the requirements outlined in [section 2.8.1](#) or other product-specific code-compliant wind rating documentation if applicable.
- Roof cover systems and their attachments must have design pressure ratings equal to or greater than the required wind uplift pressures for the site design wind speed, roof height, exposure category, and location on the building corresponding to no less than  $V_{ult} = 130$  mph (refer to [section 2.10](#) for “ultimate” vs. “nominal” wind speed) and Exposure C (refer to [Appendix D](#) for definition).
  - Refer to the appropriate FORTIFIED Design Pressure Calculator on the [FORTIFIED website](#) for guidance on required design pressures for steep-slope roof coverings



- Installation must be in accordance with manufacturer specifications for the applicable uplift pressures.
- Installation must be over continuous decking meeting minimum thickness requirements and one of the acceptable sealed roof deck underlayment options per [section 4.4](#).

**For FORTIFIED Hail Supplement requirements, refer to [section 7.2.4](#).**

## 4.8 Low-Slope (less than 2:12) Roof Coverings Only

- Roof Slope must be less than 2:12.
- Roof system must be installed over wood roof deck (verify that roofing system is appropriate for and compatible with roof deck).
- Low-slope roof cover systems must have a certified design pressure report meeting the requirements outlined in [section 2.8.1](#).
- Low-slope roof cover systems and their attachments must have design pressure ratings equal to or greater than the required wind uplift pressures for the site design wind speed, roof height, exposure category, and location on the building corresponding to no less than  $V_{ult} = 130$  mph (refer to [section 2.10](#) for “ultimate” vs. “nominal” windspeed) and Exposure C (refer to [Appendix D](#) for definition).
  - Refer to [Table B2.1](#) in [Appendix B2](#) for guidance on required design pressures for low-slope roof coverings.
- Low-slope roof system attachments must be installed in compliance with the requirements of the certified design pressure report and building code requirements.
- Installation including flashings must be in accordance with the manufacturer’s installation instructions and building code requirements.
- Drip edges must be mechanically fastened to the roof deck at the following maximum spacing:

**For Hurricane designation: 4 in O.C.**

**For High Wind designation: 12 in. O.C.**

**For FORTIFIED Hail Supplement requirements, refer to [section 7.3](#).**

## 4.9 Attic Vents and Covers (Hurricane Designation Only)

- For Hurricane designation only, ridge and off-ridge vents must be TAS 100(A) rated and anchored to the roof in compliance with manufacturer recommended installation for high winds.
- For Hurricane designation only, if off-ridge vents or ventilators require modification/mitigation actions such as removing part of the device and capping the hole when a hurricane threatens, the homeowner must be made aware of this requirement.
  - **BEST PRACTICE:** IBHS recommends against using ventilation system components that require roof access to remove it or prepare it when a hurricane threatens.
- For Hurricane designation only, gable end vents must either be TAS 100(A) rated or have removable shutters in accordance with FORTIFIED Standard Detail [F-GS-1](#) “Gable Vent Shuttering” (refer to Appendix A), and homeowner must be made aware that installation of shutters is temporary and that shutters must be removed once the hurricane threat has passed.
  - **BEST PRACTICE:** IBHS recommends against including gable end vents in new homes built in hurricane-prone regions if there are other adequate means to allow proper ventilation of the roof space.

NEW ROOF

**GENERAL NOTES:**

1. REFER TO APPLICABLE FORTIFIED HOME STANDARDS FOR ADDITIONAL INFORMATION.
2. REFER TO FORTIFIED STANDARD DETAIL F-G-1 FOR CORROSION PROTECTION REQUIREMENTS. **TO MAINTAIN PROPER ATTIC VENTILATION, VENT SHUTTERING MAY BE PERFORMED ON A TEMPORARY BASIS ONLY AND SHUTTERS ARE TO BE REMOVED AFTER A STORM THREAT IS OVER. ADEQUATE ATTIC VENTILATION MUST BE MAINTAINED ON A REGULAR BASIS.**
3. FORTIFIED HOME STANDARDS ARE TO BE APPLIED IN CONJUNCTION WITH FEDERAL, STATE, AND LOCAL CODES, ORDINANCES, AND REGULATIONS IN ADDITION TO THE STRUCTURAL DESIGN WHICH IS BY OTHERS. IN CASE OF A CONFLICT BETWEEN PROVISIONS, USE WHICHEVER IS MORE STRINGENT.

WOOD STRUCTURAL PANEL OR OTHER NON-POROUS FLAT SHUTTER CUT TO FIT W/ 1/8" MIN. THICKNESS. PRE-DRILL HOLES AT FASTENER LOCATIONS. SHAPE MAY VARY, BUT NOT TO EXCEED MAX. DIMENSIONS AND FASTENER SPACING SHOWN.

OUTLINE OF GABLE VENT BEYOND SHUTTER

PERMANENT, CORROSION-RESISTANT FASTENER THROUGH PRE-DRILLED HOLES. REFER TO TABLE F-GS-1 FOR FASTENER INFORMATION. MINIMUM OF (3) FASTENERS PER EACH PANEL SIDE REQUIRED.

SHUTTER CAN BE INSTALLED FROM OUTSIDE OF HOUSE OR FROM INSIDE OF ATTIC.

**TABLE F-GS-1: FASTENING SCHEDULE FOR GABLE VENT COVER.**

SUPPORT STRUCTURE TYPE	FASTENER TYPE & SIZE	END DISTANCE, D
WOOD	1/4" Ø LAG SCREWS W/ 2" EMBEDMENT & 1" Ø WASHER	1"
CONCRETE OR GROUTED MASONRY	1/4" Ø FASTENER W/ 2" EMBEDMENT & 1" Ø WASHER	15"

NOTES: WHERE SCREWS ARE ATTACHED TO MASONRY OR MASONRY/CEILING, USE VIBRATION-RESISTANT ANCHORS W/ 1500 LBS MIN. WITHDRAWAL CAPACITY.

NOTE: SET FLASHING WEATHER STOPPING CAN BE USED TO SEAL THE SHUTTERS TO THE TRIM BOARDS AROUND VENT EDGES. IF SHUTTER IS INSTALLED ON INSIDE OF ATTIC, ENSURE THAT WATER THAT ACCUMULATES IN THE CAVITY CAN DRAIN TO THE OUTSIDE OF THE HOUSE AND NOT INTO THE WALL BELOW.



**APPLICABLE STANDARDS:**  
FORTIFIED HOME™ - 4.0.0.0 (2020)

**DESCRIPTION:**  
TEMPORARY GABLE VENT SHUTTERING

**DRAWING #:**  
F-GS-1

**DATE:**  
11/01/2020

### F-GS-1

## 4.10 Photovoltaic (PV) Systems

- Letter of compliance required from professional engineer indicating that connections and installation of the PV system meet the design intent, and that system has been appropriately designed for the following:
  - Roof-mounted PV systems shall be designed for component & cladding wind loads for the site in accordance with ASCE 7 using an effective area based on the dimensions of a single unit frame.
  - The roof deck and supporting structure must be designed to support all gravity and wind loads resulting from the PV system installation.
- All roof penetrations must be sealed and flashed in accordance with the PV system and roof covering manufacturer's requirements.

**For FORTIFIED Hail Supplement** requirements, refer to [section 7.5](#).

## 5 Designation Requirements for FORTIFIED Silver

Achievement of a FORTIFIED Silver designation is a recognition that appropriate measures for the geographic region have been taken, in addition to the FORTIFIED Roof mitigation measures, to reduce the impact of other common amplifiers of damage caused by wind pressure and windborne debris.

### 5.1 Prerequisite Designation

- FORTIFIED Roof designation requirements per [section 3](#) or [section 4](#) have been met.

### 5.2 Windows and Skylights (Hurricane Designation Only)

**NOTE:** For FORTIFIED Silver designation, it may be sufficient to protect windows and doors with opening protection systems. However, if seeking FORTIFIED Gold designation, all windows and door assembly pressure ratings must meet or exceed the design pressures provided in Appendix [Table B2.3](#).

- For Hurricane designation only, all glazed openings (opening with glass) must be protected from impact by one of the two following options:
  - **Option 1:** Openings are impact-rated (refer to [section 2.7](#))
  - **Option 2:** Openings have qualified impact-rated opening protection systems (refer to [sections 2.7](#) and [2.8.2](#))
    - For  $V_{ult} < 130$  mph, protective systems that provide at least the level of protection of wood structural panels with a minimum thickness of  $7/16$  in. and a maximum span of 44 in. between lines of fasteners are permitted to be used as removable opening protection, attached in accordance with the requirements of FORTIFIED Standard Detail [F-GS-1](#) “Gable Vent Shuttering” (refer to Appendix A).
    - Refer to [section 2.10](#) for “ultimate” vs. “nominal” wind speed.

For **FORTIFIED Hail Supplement** requirements for skylights, refer to [section 7.4](#).

## 5.3 Entry Doors (Hurricane Designation Only)

- ❑ For Hurricane designation only, all entry doors must be protected from impact by one of the following two options:
  - **Option 1:** Entry doors are impact-rated (refer to [section 2.7](#))
  - **Option 2:** Entry doors have qualified impact-rated opening protection systems (refer to [section 2.7](#))
- ❑ For Hurricane designation only, at least one exterior entry door must be operable from inside the living space when opening protection is in place.

## 5.4 Garage Doors

**NOTE:** Garage doors in breakaway flood walls are not required to meet impact or design pressure rating requirements.

### 5.4.1 Garage Doors (Hurricane Designation Only)

- ❑ For Hurricane designation, all garage doors must be pressure-rated, and garage doors with windows must also be protected from impact per one of the options listed in Table 5.1.

**Table 5.1.** Minimum Garage Door Requirements for FORTIFIED Home–Hurricane / FORTIFIED Silver Designations

Garage Door Type	Requirement Option 1	Requirement Option 2
Garage Doors <u>with</u> Glazed Openings (Windows):	Pressure-rated <sup>1,2</sup> and impact-rated <sup>1</sup>	Pressure-rated <sup>1,2</sup> and protected by impact-rated <sup>1</sup> cover
Garage Doors <u>without</u> Glazed Openings (No Windows):	Pressure-rated <sup>1,2</sup>	N/A

#### **Notes**

1. Refer to [sections 2.7](#) and [2.8.2](#) for definitions of “impact-rated” and “pressure-rated,” respectively.
2. Pressure ratings must meet or exceed the design pressures provided in [Table B2.3](#) in [Appendix B2](#) for the exposure category (Exp. C minimum), design wind speed ( $V_{ult} = 130$  mph minimum), garage door size and location on the building. Refer to [section 2.10](#) for “ultimate” vs. “nominal” wind speed.

## 5.4.2 Garage Doors (High Wind Designation Only)

- For High Wind designation, all garage doors must pressure-rated as shown in Table 5.2.

**Table 5.2.** Minimum Garage Door Requirements for FORTIFIED Home–High Wind / FORTIFIED Silver Designations

Garage Door Type	Requirement
Garage Doors <u>with OR without</u> Glazed openings (Windows or No Windows):	Pressure-rated <sup>1,2</sup>

**Notes**

1. Refer to [section 2.8.2](#) for definition of “pressure-rated.”
2. Pressure ratings must meet or exceed the design pressures provided in [Table B2.3](#) in [Appendix B2](#) for the exposure category (Exp. C minimum), design wind speed ( $V_{ult} = 130$  mph minimum), garage door size and location on the building. Refer to [section 2.10](#) for “ultimate” vs. “nominal” wind speed.



## 5.5 Gable Ends

Refer to Figure 5.1 for illustration and identification of gable end framing terminology used in this section and elsewhere in the FORTIFIED Home Standard.

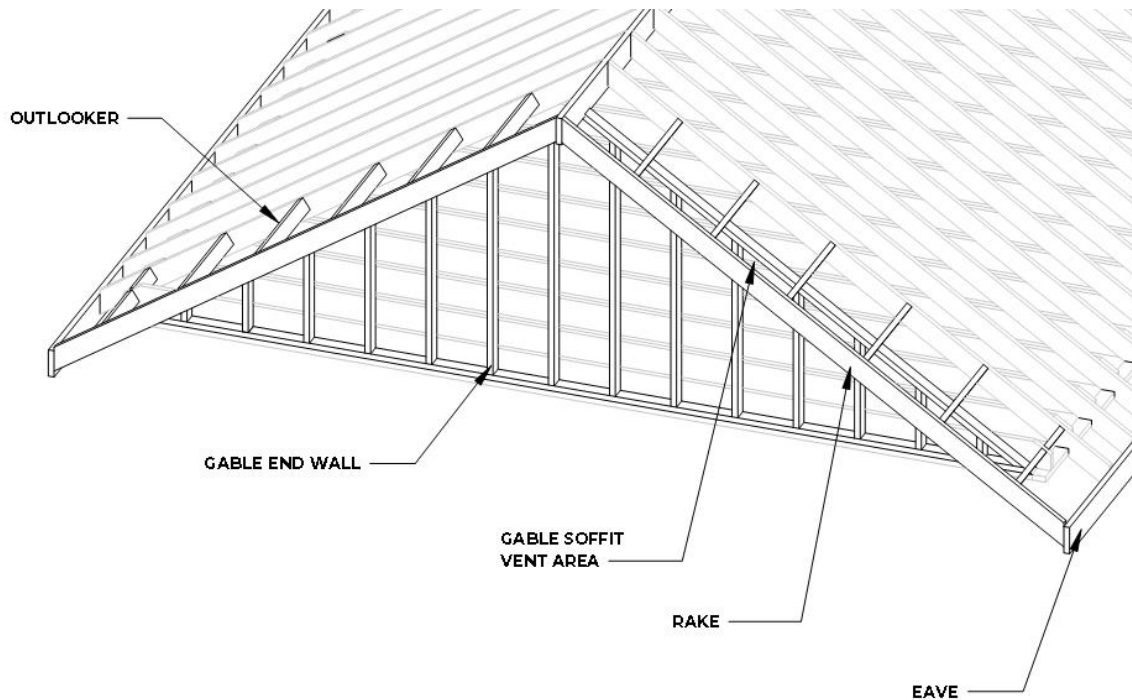

Figure 5.1. Gable end framing terminology illustration

### 5.5.1 Gable End Wall Sheathing

- Gable end wall sheathing shall be designed to have sufficient strength and fastening to resist wall design wind pressures specified in ASCE 7 or shall be in compliance with approved prescriptive provisions.
- Gable end wood structural panel wall sheathing shall have a minimum thickness of  $7/16$  in.
  - FORTIFIED requirements are based on minimums of  $V_{ult} = 130$  mph and Exposure C. For conditions that exceed these minimums, refer to WFCM Table 3.13A (2015 Edition for ASCE 7-10 or 2018 Edition for ASCE 7-16) for prescriptive guidance. Refer to [section 2.10](#) for “ultimate” vs. “nominal” wind speed.
- Gable end wall system shall provide impact resistance of at least the level of protection of wood structural panels with the minimum required thickness.

SILVER

## 5.5.2 Gable End Wall Framing and Bracing

Gable ends over 3 ft tall must be properly designed for site conditions with adequate connections along the top and bottom and must be properly braced against positive and negative wind pressures. Gable end framing and bracing shall be either properly designed or retrofitted per one of the following options:

- **Option 1:** Gable end framing, connections and bracing shall be designed by a professional engineer (refer to [Appendix D](#) for definition) for the appropriate exposure category, design wind speed, mean roof height and location on the building to resist the appropriate positive and negative lateral wind loads and wind uplift.
  - Site-specific gable end and bracing designs shall be documented on the SC1 Silver Compliance Form for Engineer and signed by the professional engineer responsible for the design.
  - Gable end and bracing installation must be documented on SC2 Silver Compliance Form for Contractor and signed by the contractor responsible for installation.
- **Option 2:** Gable end framing and bracing (for gables 3 ft and taller unless otherwise specified by locally adopted building code) shall be retrofitted in accordance with the locally adopted building code if both building and gable end walls meet the corresponding eligibility requirements for retrofitting. Prescriptive gable end retrofit in accordance with IBC or FBC provisions specified below shall be acceptable in lieu of superseding local code provisions:
  - **2018 International Existing Building Code, Appendix C, Chapter C1: Gable End Retrofit for High Wind Area** <https://codes.iccsafe.org/content/IEBC2018P3/appendix-c-guidelines-for-the-wind-retrofit-of-existing-buildings>
  - **2017 Florida Building Code – Existing Building 6<sup>th</sup> Edition, Chapter 17 – Retrofitting** <https://codes.iccsafe.org/content/FEBC2017/chapter-17-retrofitting>
  - Ceiling diaphragm shall meet the following minimum requirements unless otherwise specified in retrofit provisions:
    - 1/2 in. minimum thickness for drywall
    - 3/8 in. minimum thickness for plywood or plaster installed over wood lath
  - Prescriptive gable end retrofit installation must be documented on the SC2 Silver Compliance Form for Contractor and signed by the contractor responsible for installation.
  - Cases not covered in prescriptive retrofit guidance include (but are not limited to) the following:
    - Gable end walls on rooms with vaulted or cathedral ceilings
    - Gable ends taller than 16 ft and/or have irregular shape

### 5.5.3 Gable End Overhang Construction (Hurricane Designation Only)

- For Hurricane designation only, gable end overhangs that exceed 12 in. long for ASCE 7-10 or 9 in. long for ASCE 7-16, shall be constructed and connected as outlookers in accordance with FORTIFIED Standard Detail [F-GE-1](#) “Prescriptive Gable End Outlooker Framing and Anchorage” (refer to Appendix A) or designed by a professional engineer (refer to [Appendix D](#) for definition).
  - Signed and sealed site-specific outlooker design details shall be provided by the engineer responsible for the design and documented on the SC1 Silver Compliance Form for Engineer.
    - Outlookers and/or gable end wall or truss must not be notched.
    - Blocking shall be installed between the outlookers and attached to the top of the gable wall truss or framed wall top plate.

**Table F-GE-1.** From F-GE-1: Rake Overhang Outlooker Maximum Length and Connection Requirements

Ultimate Wind Speed, $V_{ult}$ (mph)	Exposure B&C		Exposure D	
	Max. Overhang Length (in) <sup>1</sup>	Uplift Connection at Gable End <sup>1,3,4,5</sup>	Max. Overhang Length (in) <sup>1</sup>	Uplift Connection at Gable End <sup>1,3,4,5</sup>
130	24	Simpson H10A USP RT16A	22	Simpson H10A USP RT16A
140	22	Simpson H10A USP RT16A	18	Simpson H10A USP RT16A
150	20	Simpson H10A USP RT16A	16	Simpson H10A USP RT16A
160	16	Simpson H10A USP RT16A	14	Simpson H10A USP RT16A
170	14	Simpson H10A USP RT16A	14	Simpson H14
180	14	Simpson H14	14	Simpson H14

**Notes**

1. Both outlooker framing spacing and connector spacing are @ 24 in. O.C. max.
2. Loads are per the 2018 Wood Frame Construction Manual and ASCE 7-16.
3. Simpson H10A connection requires (9) 0.148-in. x 1½-in. nails to outlooker and (9) 0.148-in. x 1½-in. nails to gable end top chord.
4. USP RT16A connection requires (9) 0.148-in. x 1½-in. nails to outlooker and (8) 0.148-in. x 1½-in. nails to gable end top chord.
5. Simpson H14 connection requires (12) 0.131-in. x 1½-in. nails to outlooker and (15) 0.131-in. x 2½-in. nails to gable end top chord.

SILVER

(5.5.3 Gable End Overhang Construction [Hurricane Designation Only] Continued)

**Outlooker Connections**

Prescriptive outlooker connections to gable end roof member shall be in accordance with Table F-GE-1, and connections to second roof member (i.e., connection at backspan) shall be Simpson LU24 or USP JL24 joist face hanger with (4) 0.162-in. x 3½-in. nails to roof member and (2) 0.148-in. x 1½-in. nails to outlooker. Refer to **F-GE-1** for additional guidance.

**GENERAL NOTES:**  
REFER TO APPLICABLE FORTIFIED HOME'S OVERHANG CONNECTION INFORMATION.  
SOFT FRAMING IN GABLE END OVERHANGS CANNOT BE VENTED.  
ROOF-FRAME STRUCTIONS ARE TO BE REVIEWED IN CONJUNCTION WITH FEDERAL, STATE, AND LOCAL CODES, ORDINANCES AND REGULATIONS. IN ADDITION TO THE STRUCTURAL DESIGN WHICH IS PROVIDED, IN CASE OF A CONFLICT BETWEEN PROVISIONS, USE WHICHEVER IS MORE STRINGENT.

ROOF SINGING MAX. 2" THICK NAIL PER FORTIFIED REQUIREMENTS.

NO LESS THAN OVERHANG.

REFER TO FORTIFIED HOME ILLUSTRATED STANDARD FOR SOFT REQUIREMENTS.

GABLE END TRUSS (FRAMED GABLE END WALL SKYLIGHT).

(GABLE END) DROPPED WIDTH OF OUTLOOKER.

NAILS INTO GABLE END TOP CHORD OR 2" (MIN) THICK TOP PLATE IF FINISHED GABLE END WALL.

ROOF FRAMING MEMBERS @ MAX. 24" O.C. TYP.

SIMPSON LU24 OR USP JL24 JOIST FACE HANGER W/ (4) 0.162 X 3-1/2 NAILS TO TRUSS AND (2) 0.148 X 1-1/2" NAILS TO OUTLOOKER.

SA 3024 - W/ HURRICANE CLIP (ALL CASES) REFER TO TABLE F-GE-1 FOR MINIMUM CLIP CONNECTION REQUIREMENTS.

TOP OF GABLE MUST BE DROPPED WIDTH OF OUTLOOKER.

2" X 4" CONTINUOUS OUTLOOKER F.L.N. @ MAX. 24" O.C. TYP. OUTLOOKER MUST BE POSITIONED IN EDGEWISE OR ENDWISE CLIP WHERE NOT ACCEPTABLE.

**TABLE F-GE-1: GABLE OVERHANG OUTLOOKER MAXIMUM LENGTH AND CONNECTION REQUIREMENTS.**

Ultimate Wind Speed $V_w$ (mph)	Max. Overhang Length (ft)	Exposure B/C		Exposure D	
		Qualif. Connector at Gable End <sup>(1)</sup>	Max. Overhang Length (ft)	Qualif. Connector at Gable End <sup>(2)</sup>	Max. Overhang Length (ft)
130	24	Simpson H24A USP H24A	22	Simpson H24A USP H24A	22
140	22	Simpson H20A USP H20A	18	Simpson H20A USP H20A	18
150	20	Simpson H20A USP H20A	16	Simpson H20A USP H20A	16
160	18	Simpson H20A USP H20A	14	Simpson H20A USP H20A	14
170	14	Simpson H14A USP H14A	14	Simpson H14A USP H14A	14
180	14	Simpson H14A USP H14A	12	Simpson H14A USP H14A	12

**NOTES:**  
1. See Outlooker Framing and Connector Spacing in 24" O.C. max.  
2. Use as per the 2018 wood frame construction manual, and 2021 7-26.  
3. Simpson H24 connector requires (2) 0.162 x 3-1/2" nails to outlooker and (2) 0.148 x 1-1/2" nails to gable end top chord.  
4. USP H24 connector requires (2) 0.162 x 3-1/2" nails to outlooker and (2) 0.148 x 1-1/2" nails to gable end top chord.  
5. Simpson H14 connector requires (2) 0.162 x 3-1/2" nails to outlooker and (2) 0.148 x 1-1/2" nails to gable end top chord.

TYPICAL JOIST HANGER PERSPECTIVE VIEW

TYPICAL SIMPSON TYPE CLIP PERSPECTIVE VIEW

**APPLICABLE STANDARDS:**  
FORTIFIED HOME™ ILLUSTRATED

**DESCRIPTION:**  
PREScriptive GABLE END OUTLOOKER FRAMING AND ANCHORAGE

**DRAWING #:**  
F-GE-1

**DATE:**  
11/01/20

**F-GE-1**

SILVER

## 5.5.4 Vented Gable End Rake Soffits (Hurricane Designation Only)

For Hurricane designation only, a builder/contractor or other design professional should be consulted to determine if gable end rake soffits are required to be vented to comply with attic ventilation requirements. If gable end rake soffits are not required to be vented, then they shall be blocked by one of the two following options:

- **Option 1:** Remove the vented soffit material and reinstall a non-porous soffit material to the bottom of the outlookers in accordance with the manufacturer's installation requirements for high-wind areas.
- **Option 2:** Plug the gaps from the inside with metal flashing and sealant (or wood blocking with caulk adhesive). The flashing should be well attached and completely seal the openings. Use sealant around the edges.



Figure 5.2. Blocking of gable rake soffit vents using metal flashing



## 5.6 Soffits (Hurricane Designation Only)

### For New Homes (Hurricane Designation Only):

- For new homes, vinyl or aluminum soffits are limited to 12 in. between support members and must be installed in accordance with the soffit manufacturer’s instructions.
  - Aluminum soffit covers may not be used within 3,000 ft of the coast.

### For Existing Homes (Hurricane Designation Only):

#### For Existing Soffit Covers in Good Condition:

- Assess condition of existing soffit cover. Existing soffit cover may be used if it is in good condition.
  - Existing soffit cover may not be brittle, deteriorated, cracked, torn, or damaged
  - Aluminum soffit cover may not be used within 3,000 ft of the coast
- If existing soffit cover manufacturer is known, verify that it is installed in compliance with manufacturer’s installation details and requirements for soffit support and panel attachment for the appropriate design wind pressure and product model.
  - One source for this information is the Florida Building Code Product Approval website which provides information on soffit manufacturers’ installation guidance for specific design pressures.
  - Refer to [Table B2.2](#) in [Appendix B2](#) for guidance on appropriate design pressures.
- If existing soffit cover is not installed in compliance with manufacturer’s specifications or if manufacturer is not known, soffit overhangs extending more than 12 in. from the wall must have a brace/support installed in accordance with FORTIFIED Standard Detail [F-S-1](#) “Soffit Retrofit Detail” (refer to Appendix A) such that the unsupported soffit is not more than 12 in.

#### For Existing Soffit Covers Not in Good Condition:

- If existing soffit cover is not in good condition, existing soffit cover shall be removed and replaced with new soffit cover installed per manufacturer specifications for the appropriate design wind pressure.
  - Refer to FORTIFIED Standard Detail [F-S-1](#) “Soffit Retrofit Detail” (refer to Appendix A) for guidance on appropriate design pressures.

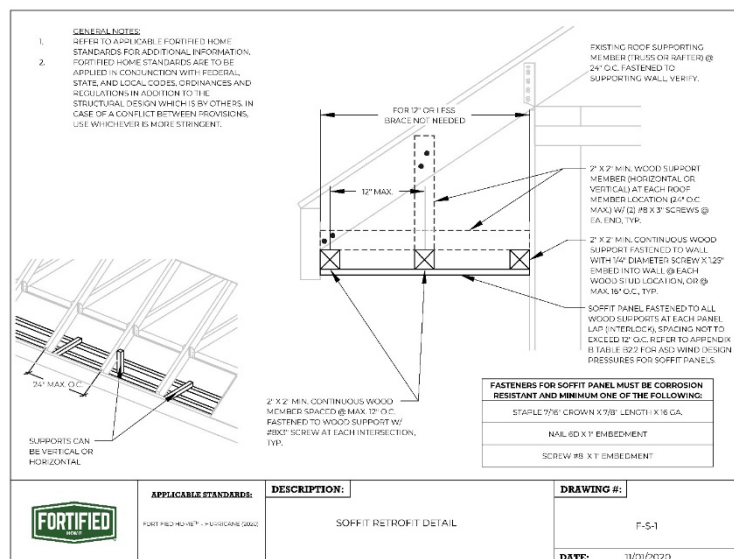

**F-S-1**



## 5.7 Chimneys

- Chimneys must be adequately connected to the roof structure to resist loads based on site design wind speed and exposure category. Certification from a professional engineer (refer to [Appendix D](#) for definition) is required for new construction and for existing construction when connections are concealed by finished materials. Professional engineer shall provide detailing similar to FORTIFIED Standard Detail [F-CTD-1](#) “Chimney Tie-Down Detail” (refer to Appendix A) including the following:
  - Chimney wall framing adequacy
  - Overall over-turning stability and base shear requirement
  - Roof support members adequacy and bracing requirement
  - Specific attachment schedule of chimney structure to the existing structure
  
- **EXCEPTION:** For existing homes, prescriptive retrofit in accordance with FORTIFIED Standard Detail [F-CTD-1](#) may be acceptable in lieu of certification from a professional engineer if the following criteria are met:
  - Chimney extends less than 5 ft above the roof deck
  - Chimney is not located along the edge of the roof

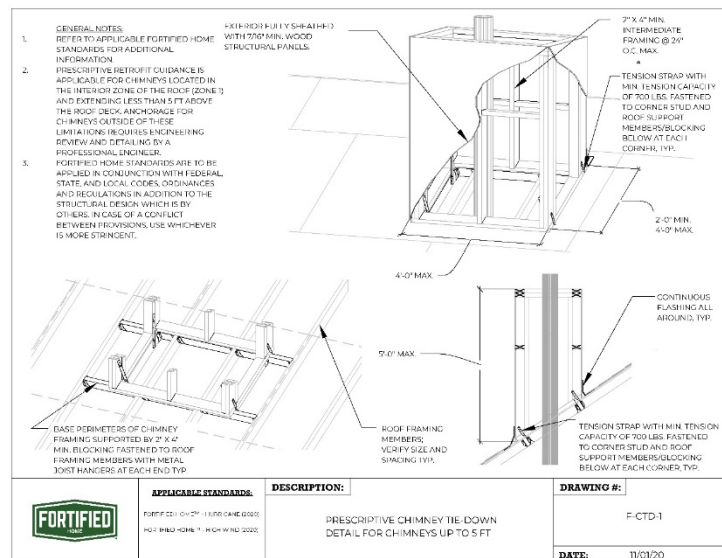

**F-CTD-1**

SILVER

## 5.8 Attached Structures

An attached structure is an outdoor or semi-outdoor space with a solid roof that is attached to an exterior wall or the roof structure of the main building. This includes both structures that are part of the main building construction and continuous load path (CLP) and also add-on structures connected to the home for support that are not part of the main CLP design. This does not include detached structures that are not connected to the main building.

- Attached structures such as porches and carports must have adequate connections for uplift pressures based on site design wind speed and exposure category. Certification from a professional engineer (refer to [Appendix D](#) for definition) is required for new construction and when connections are concealed by finished materials. The following connections must be provided and verified:

**NOTE: Nail-only connections (such as toe-nailed connections) for roof, beam, and column connections are not permitted for FORTIFIED and are an immediate disqualifier.**

### **For single-level attached structures:**

- Roof framing must be directly connected to roof beam with metal connectors.
- Roof beam must be directly connected to columns with metal connectors or a minimum of (2) bolts.
- Columns must be connected to foundation with metal connectors or a minimum of (2) bolts.

### **For multi-level attached structures** (multi-level porch with middle floor level):

- Roof framing must be directly connected to roof beams with metal connectors.
  - Roof beams must be directly connected to upper level columns with metal connectors or a minimum of (2) bolts.
  - Upper-level columns must be connected directly to one of the following at their bottom:
    - Lower-level columns with metal connectors or (2) bolts minimum.
    - Middle floor structural support beams with metal connectors or (2) bolts minimum.
  - Middle floor beams must be attached to lower-level columns/pilings/piers with metal connectors or a minimum of (2) bolts.
  - Lower-level columns must be directly connected to foundation with metal connectors or a minimum of (2) bolts or have proper embedment depth/footing specified.
- **EXCEPTION:** For existing homes, prescriptive retrofit options for wood framed structures may be acceptable in certain situations using the FORTIFIED Porch/Carport Calculator available on the [FORTIFIED website](#).
    - To be eligible for prescriptive retrofit, the attached structure must meet the following conditions:
      - Rectangular or square plan; 20 ft D x 25 ft W max. w/ 1.5 ft max. overhang
      - Flat, monoslope roof
      - Weight of roof = 7 psf min.
      - Mean roof height = 15 ft max.

- Framing geometry as shown below in Figure 5.3:

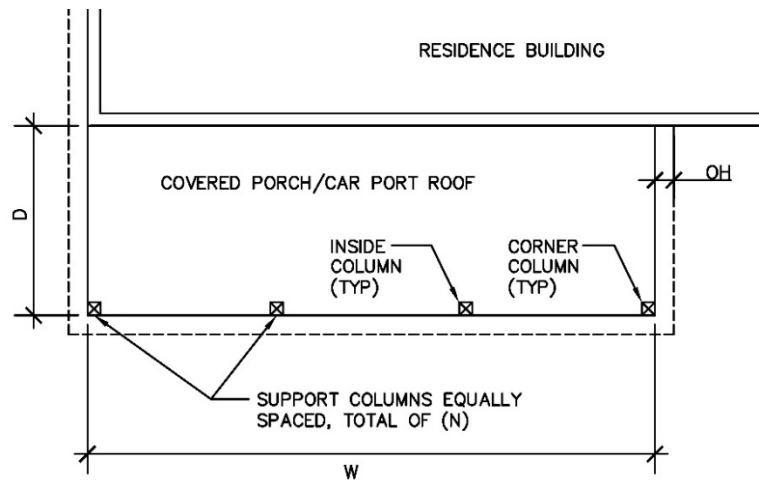

**Figure 5.3. Framing Geometry for Prescriptive Retrofit of Attached Structures**

- The required uplift reactions provided by the calculator can be used to select connectors whose published allowable uplift capacities meet or exceed the required loads provided by the calculator when installed per manufacturer installation instructions.
- Site-specific attached structure designs shall be documented on the SC1 Silver Compliance Form for Engineer and signed by the professional engineer responsible for the design.
- Attached structure installation must be documented on the SC2 Silver Compliance Form for Contractor and signed by the contractor responsible for installation.

## 6 Designation Requirements for FORTIFIED Gold

Achievement of a FORTIFIED Gold designation is a recognition that measures have been taken, in addition to the FORTIFIED Roof and FORTIFIED Silver mitigation measures, to ensure that critical structural load path connections of the home have been considered by the appropriate building professionals and weak links likely to result in structural damage have been strengthened. It does NOT mean that structural damage will not occur.

### 6.1 Prerequisite Designations

- FORTIFIED Roof designation requirements per [section 3](#) or [section 4](#) have been met.
- FORTIFIED Silver designation requirements per [section 5](#) have been met.

### 6.2 Wind Pressure Resistance of Windows and Doors (Hurricane Designation Only)

- All openings (windows, skylights, glass blocks, glass doors, entry doors, and garage doors) must be pressure-rated (refer to [section 2.8.2](#)).
  - Design Pressure ratings must meet or exceed site-specific required design pressures corresponding to a minimum of  $V_{ult} = 130$  mph and Exposure C for the opening size and location on the building and must be installed in accordance with the manufacturer's instructions. Guidance for required design pressures for openings is provided in [Table B2.3](#) in Appendix B2.

**For FORTIFIED Hail Supplement** requirements for skylights, refer to [section 7.4](#).

### 6.3 Wall Impact Resistance (Hurricane Designation Only)

- Exterior walls must be constructed using a wall system that provides, at minimum, the resistance to wind pressures and debris impact provided by  $7/16$ -in.-thick wood structural panels attached to wood wall framing.

## 6.4 Continuous Load Path (CLP) Options for New Homes

The CLP options in section 6.4 are applicable for new construction meeting the following requirements:

- The Certificate of Occupancy has been issued less than 12 months prior to the application being made to IBHS.
- All required documentation has been obtained during the construction process and has been provided to IBHS.

For construction that does not meet the above requirements, refer to [section 6.5](#) “Continuous Load Path for Retrofit of Existing Homes.”

### 6.4.1 Custom Engineered CLP Design by Professional Engineer

- For new homes, a professional engineer (refer to [Appendix D](#) for definition) may incorporate the continuous load path in the home’s design plans. Continuous load path design shall include, but shall not be limited to the following minimum elements designed in conformance with IRC/IBC or with sound engineering practices corresponding to the appropriate design wind speed, exposure category, mean roof height and number of stories and also incorporating the minimum FORTIFIED requirements listed:
  - **Roof framing design including roof diaphragm design**
    - EOR must review the design of roof framing members by specialty engineer (i.e., trusses).
  - **Floor framing design including floor diaphragm design**
    - EOR must review the design of floor framing members by specialty engineer (i.e., trusses).
  - **Wall framing design including shear wall design**
    - Shear walls must be designed as either full height, fully sheathed walls or moment frames, and there must be sufficient percentage of full height walls on all building sides to adequately transfer shear loads.
    - CMU/concrete walls must be 8 in. (nominal) minimum width.
    - At top of all CMU/concrete walls, fully grouted bond beams with continuous reinforcement including required laps at corners and intersections must be specified.
    - For CMU/concrete walls, vertical reinforcement must be specified at a regular O.C. spacing and at all corners including required ties to bond beam reinforcement at top and foundation reinforcement at bottom.
    - For CMU/concrete walls, lintels and vertical cells around all wall openings (windows/doors) must be fully grouted with vertical and horizontal reinforcement including ties specified.
  - **Foundation design**
    - Slab-on-grade or stem wall foundation design (including retaining wall design if applicable) must include vertical reinforcement at corners and in grouted cells at an adequate spacing.
    - For elevated foundations (such as piers/pilings), beams spanning between pilings, embedment depth of pilings if applicable and bracing/reinforcing of





## 6.4.2 Prescriptive CLP Design for Wood Framing by Design Professional (High Wind Designations Only)

- FORTIFIED Home–High Wind allows a prescriptive CLP design option to be completed by a licensed design professional for wood-framed homes with parameters that conform to the limitations noted below. Wood framed homes with parameters that fall outside of these limitations, may be considered on a case-by-case basis and shall require a professional engineer (Refer to [Appendix D](#) for definition) to oversee the prescriptive design in accordance with [section 6.4.3](#).
- For new wood framed homes, a licensed design professional may use the American Wood Council’s (AWC) Wood Frame Construction Manual to specify the continuous load path requirement:
  - Building parameters and design must conform to the limitations of the Wood Frame Construction Manual.
  - Building parameters and design must conform to the additional FORTIFIED limitations listed in [Appendix F](#).
- Installation of the continuous load path elements shall be documented on the GC5 Gold Compliance Form for Contractor – Prescriptive CLP for High Wind Only New Construction and signed by contractor responsible for installation.

## 6.4.3 Prescriptive CLP Design by Professional Engineer

- For wood framed homes that fall outside the limitations of [section 6.4.2](#) and/or home constructed of building materials other than wood, such as cold-formed steel (CFS), insulated concrete forms (ICF) or concrete masonry units (CMU), prescriptive design options may be considered on a case-by-case basis and shall require a professional engineer (Refer to [Appendix D](#) for definition) to oversee the prescriptive design and to confirm the following:
  - Prescriptive method used is in accordance with current accepted engineering practices and in compliance with the local building code
  - The building parameters and site conditions are within the scope of the prescriptive method limits
  - The correct design specifications from the prescriptive method for the building parameters and site conditions have been utilized
  - Systems and connections that are part of the CLP design but fall outside the limits of the prescriptive method have been properly designed (i.e., including but not limited to roof system, roof to wall connections, floor system(s), foundation, foundation to wall connections, etc.)
  - Lateral loads have properly been accounted for in design
- Complete continuous load path design provided by the professional engineer and shall include, but shall not be limited to the minimum elements outlined in [section 6.4.1](#) designed in conformance with IRC/IBC or with sound engineering practices corresponding to the appropriate design wind speed, exposure category, mean roof height and number of stories, with the minimum FORTIFIED requirements incorporated.

- ❑ Complete Continuous load path design incorporating the prescriptive method used shall be documented on the GC1 Gold Compliance Form for Engineer – Engineered CLP for New Construction and signed by the professional engineer responsible for the design.
- ❑ Installation of the continuous load path elements shall be documented on the GC2 Gold Compliance Form for Contractor – Engineered CLP for New Construction and signed by contractor responsible for installation.

## 6.5 Continuous Load Path for Retrofit of Existing Homes

Retrofitting an existing home structure to meet the FORTIFIED Gold requirements can be a complicated undertaking that may fall outside the homeowner's budget and time constraints. Much depends on the existing condition of the home and the accessibility of the structural components requiring investigation and retrofit. This option is applicable for existing homes where the Certificate of Occupancy has been issued more than 12 months prior to the application being made to IBHS.

- ❑ A professional engineer (refer to [Appendix D](#) for definition) must perform site inspections(s) to identify structural components that need retrofitting to meet the requirements of current building code, minimum structural safety requirements, and FORTIFIED Roof, FORTIFIED Silver, and FORTIFIED Gold requirements. Refer to [Appendix G](#) for a list of the minimum elements that must be inspected and assessed by the professional engineer.
- ❑ Continuous load path design shall be documented on the GC3 Gold Compliance Form for Engineer – CLP for Retrofit of Existing Home and signed by the professional engineer responsible for the design.
- ❑ Installation of the continuous load path elements shall be documented on the GC4 Gold Compliance Form for Contractor – CLP for Retrofit of Existing Home and signed by contractor responsible for installation.

# 7 Designation Requirements for FORTIFIED Hail Supplement Only

## 7.1 Applying Hail Requirements in Conjunction with Wind Requirements

Sections 3 through 6 of the FORTIFIED Home Standard include provisions to mitigate against wind and/or wind-driven rain hazards and provide the requirements to achieve a High Wind or Hurricane designation at the FORTIFIED Roof, FORTIFIED Silver or FORTIFIED Gold level.

This section (section 7) provides the requirements to achieve a supplemental Hail designation and is intended to be used in conjunction with sections 3 through 6 to achieve a combined High Wind & Hail or Hurricane & Hail designation.

To achieve a High Wind & Hail or Hurricane & Hail designation, the roof cover and any skylights or roof-mounted photovoltaic systems must meet the requirements of sections 3 through 6 and section 7.

## 7.2 Steep-Slope Roof Coverings Only

### 7.2.1 Asphalt Shingles

- Asphalt shingles must have an IBHS Roof Shingle Hail Impact Rating of “Excellent” or “Good”

*The [IBHS Impact Resistance Test Protocol for Asphalt Shingles](#) is a test standard that was developed in 2019 to evaluate the hail performance of new asphalt shingle roof products. The test method uses state-of-the-art hailstone characteristics, kinetic energies, and damage assessment technology to evaluate new shingle performance against hail. IBHS has published, and will periodically refresh, the performance ratings for the most widely sold, basic impact resistant shingles when subjected to 2-in. impacts according to the test protocol. [Products with a Good or Excellent rating](#) must be used. Refer to [Appendix E](#) for the list of IBHS roof shingle hail impact ratings as of October 1, 2019.*

**NOTE:** For asphalt shingle products that have not yet been tested by IBHS and therefore do not appear on the IBHS Impact Ratings List, documentation must indicate that the products are polymer-modified and have either a UL 2218 Class 4 rating or FM 4473 Class 4 rating to be eligible.

(7. Designation Requirements for FORTIFIED Hail Supplement Only Continued)

## 7.2.2 Clay and Concrete Roof Tiles

- FM 4473 Class 4

*FM 4473 is a test standard administered by Factory Mutual Research and is a test that uses pure water frozen ice balls to evaluate impact resistance of new rigid roof covering materials (like concrete tile, clay tile, or slate). It involves firing the ice balls from a sling or air cannon at the roof-covering product. A Class 4 rating requires the product to still be functional following two impacts in the same spot with 2-in. ice balls. Clay and concrete roof tiles must meet a Class 4 impact rating.*

## 7.2.3 Metal Panels

- UL 2218 Class 4

*UL 2218 is a test standard developed by Underwriters Laboratories for assessing the impact resistance of new flexible roofing products, like metal panels or metal shingles. It involves dropping steel balls of varying sizes from heights designed to simulate the energy of falling hailstones. Class 4 indicates that the product was still functional after being struck twice in the same spot by 2-in. steel balls. Class 4-rated products must be used.*

*It should be noted that while impact-resistant metal roofs have good impact resistance and are likely to survive most hailstone sizes without functional damage, metal roofs can be vulnerable to aesthetic damage since hail can cause permanent indentations in the roofing panels. Use of metal roofing products with granular coatings may reduce the visibility of small indentations.*

## 7.2.4 Other Roof Coverings

- For all other roof coverings, documentation must indicate that the roof cover has either a UL 2218 Class 4 rating or FM 4473 Class 4 rating to be eligible for FORTIFIED Home Hail Designation.

## 7.3 Low-Slope Roof Coverings Only

- Low-slope roof covers must meet one of the following test standards:
  - FM 4470 with a Class 1-SH or 1-VSH
  - UL 2218 Class 4

(7. Designation Requirements for FORTIFIED Hail Supplement Only Continued)

## 7.4 Skylights

- Skylights shall meet at least one of the following impact rating requirements:
  - ASTM E1886 cyclic pressure test requirements and be ASTM E1996 missile impact-rated “B,” “C,” “D,” or “E”
  - FM Approved per ANSI/FM 4431, with Severe Hail Rating
  - Miami-Dade County Approved (MDCA) with current Notice of Acceptance

## 7.5 Photovoltaic (PV) Systems

- Roof-mounted photovoltaic (PV) systems require the following:
  - Flexible PV modules that are FM Approved for hail or meet FM 4476 that includes a Severe Hail rating
  - Rigid PV modules that are FM Approved for hail or meet FM 4478 that includes a Class 4 rating
  - Rigid modules that meet UL 1703 Standards for Flat-Plate Photovoltaic Modules and Panels

## 8 Appendices

[Appendix A. FORTIFIED Home™ Standard Details](#)

[Appendix B. Design Information](#)

[Appendix C. References](#)

[Appendix D. Definitions](#)

[Appendix E. IBHS Roof Shingle Hail Impact Ratings](#)

[Appendix F. FORTIFIED Prescriptive CLP Design Limitations and Minimum Requirements for High Wind](#)

[Appendix G. FORTIFIED CLP Guidance for Retrofit of Existing Homes](#)





Detail Number	Detail Title	Applicable Level		
		Roof	Silver	Gold
<a href="#">F-G-1</a>	Corrosion Protection Requirements	✓	✓	✓
<a href="#">F-G-2</a>	Roof and Wall Zone Diagram	✓	✓	✓
<a href="#">F-RS-1</a>	Roof Deck Attachment - Sawn Lumber or Wood Board Roof Deck with No Gaps	✓	✓	✓
<a href="#">F-RS-2</a>	Hurricane - New Construction Roof Deck Attachment - Structural Wood Panels	✓	✓	✓
<a href="#">F-RS-3</a>	High Wind - New Construction Roof Deck Attachment - Structural Wood Panels	✓	✓	✓
<a href="#">F-SRD-1</a>	Roof Deck Attachment and Sealed Roof Deck from Within Using Spray Foam	✓	✓	✓
<a href="#">F-SRD-2</a>	Steep Slope Sealed Roof Deck - Flashing Tape and Underlayment- Shingle or Metal Roof Covers	✓	✓	✓
<a href="#">F-SRD-3</a>	Steep Slope Sealed Roof Deck - Two Layers Felt Underlayment - Shingle or Metal Roof Covers	✓	✓	✓
<a href="#">F-SRD-4</a>	Steep Slope Sealed Roof Deck - Self-Adhered Membrane (Showing Bond Break for Asphalt Shingles) - Shingle and Metal Roof Covers	✓	✓	✓
<a href="#">F-SRD-5</a>	Steep Slope Sealed Roof Deck - Flashing Tape, Underlayment and Roof Tile Cap Sheet - Concrete and Clay Tile Roof Covers	✓	✓	✓
<a href="#">F-SRD-6</a>	<b>NEW FOR 2020</b> Steep Slope Sealed Roof Deck - Self-Adhered Membrane - Concrete and Clay Tile Roof Covers			
<a href="#">F-DE-1</a>	Hurricane - Drip Edge Installation Over Underlayment	✓	✓	✓
<a href="#">F-DE-2</a>	<b>DISCONTINUED IN 2020</b>	N/A	N/A	N/A
<a href="#">F-DE-3</a>	High Wind - Drip Edge Installation Over Underlayment	✓	✓	✓
<a href="#">F-RC-1</a>	Asphalt Shingle Installation Guidance for Steep Slope - Option 1: Peel and Stick Starter Strip Installation at Eave or Rake	✓	✓	✓
<a href="#">F-RC-2</a>	Asphalt Shingle Installation Guidance for Steep Slope - Option 2: Shingle Strip Starter Installation at Eave or Rake	✓	✓	✓
<a href="#">F-RC-3</a>	Asphalt Shingle Installation Guidance for Steep Slope - Option 3: Shingles Set Directly in Flashing Cement at Rake Only	✓	✓	✓
<a href="#">F-RR-1</a>	Re-Roofing Deck Replacement Fastening Detail	✓	✓	✓
<a href="#">F-RR-2</a>	Re-Roofing New Scab Member Detail for Damaged or Deteriorated Wood Framing Member	✓	✓	✓
<a href="#">F-RR-3</a>	Hurricane - Re-Nailing the Roof Deck (Wood Structural Panels)	✓	✓	✓
<a href="#">F-RR-4</a>	High Wind - Re-Nailing the Roof Deck (Wood Structural Panels)	✓	✓	✓
<a href="#">F-RR-5</a>	<b>NEW FOR 2020</b> Fastening Wood Structural Panel Roof Sheathing Over Existing 1x Roo Deck Boards with Gaps	✓	✓	✓
<a href="#">F-GS-1</a>	Temporary Gable Vent Shuttering	✓	✓	✓
<a href="#">F-GE-1</a>	<b>NEW FOR 2020</b> Prescriptive Gable End Outlooker Framing and Anchorage	N/A	✓	✓
<a href="#">F-S-1</a>	<b>NEW FOR 2020</b> Soffit Retrofit Detail	N/A	✓	✓
<a href="#">F-CTD-1</a>	<b>NEW FOR 2020</b> Prescriptive Chimney Tie-Down Detail for Chimneys up to 5 ft	N/A	✓	✓

F-G-1

	<b>FORTIFIED Home™</b> <b>Corrosion Protection Requirements for Fasteners &amp; Connectors in Coastal Regions</b> For all connections described in this table: if corrosion is observed at time of re-designation, designation may not be renewed.			
	<b>Requirements &amp; Best Practices for FORTIFIED Roof™ Designations</b>			
<b>APPLICABLE STANDARDS:</b> FORTIFIED HOME™ - HURRICANE (2020) FORTIFIED HOME™ - HIGH WIND (2020)	<b>REQUIREMENTS</b>		<b>BEST PRACTICES</b>	
	<i>Distance to saltwater shoreline<sup>2</sup></i>		<i>Distance to brackish water shoreline</i>	
	<b>ROOF CONNECTIONS</b>		<b>0-300 ft</b> <b>300-3000 ft</b>	
	Roofing nails for shingles	Category A	Category B (or better)	Category B (or better)
	Concrete and clay roof tile fasteners			
	Roof vent fasteners			
	Metal roof system including panels and exposed fasteners, clips, etc.		Follow manufacturer's corrosion resistance guidance for coastal areas. If not provided by manufacturer, the following corrosion resistance categories may be accepted for exposed fasteners and clips	
	Fasteners used for attachment of underlayment to roof deck		Category B (or better)	
	Roof-mounted equipment exposed connections and fasteners		Category A	Category B (or better)
	<b>Requirements and Best Practices for FORTIFIED Silver™ and FORTIFIED Gold™ Designations</b>			
<b>REQUIREMENTS</b>		<b>BEST PRACTICES</b>		
<i>Distance to saltwater shoreline<sup>1</sup></i>		<i>Distance to brackish water shoreline</i>		
<b>EXTERIOR EXPOSED CONNECTIONS</b> (including under soffits and elevated foundations)		<b>0-300 ft</b> <b>300-3000 ft</b>		
<b>Silver:</b> <ul style="list-style-type: none"> <li>Soffit fasteners</li> <li>Exposed attached structure connectors, anchors, fasteners</li> </ul>		Category A	Category B (or better)	Category B (or better)
<b>Gold:</b> Exposed CLP connectors, anchors, fasteners		Aluminum Soffits NOT Allowed	Aluminum Soffits Allowed	
<b>BEST PRACTICES</b>		<b>BEST PRACTICES</b>		
<i>Distance to saltwater shoreline<sup>2</sup></i>		<i>Distance to brackish water shoreline</i>		
<b>INTERIOR CONNECTIONS</b> (including enclosed in attic or within wall cavity)		<b>0-300 ft</b> <b>300-3000 ft</b>		
<b>Silver:</b> <ul style="list-style-type: none"> <li>Gable bracing metal connectors and fasteners</li> <li>Gable outlooker hangers, clips and fasteners</li> <li>Chimney framing metal connectors and fasteners</li> </ul>		Category B (or better)		Category C (or better)
<b>Gold:</b> Enclosed CLP connectors, anchors, fasteners		Category C (or better)		
<b>Corrosion Resistance Categories<sup>2,3</sup></b>				
<b>CATEGORY A - STAINLESS STEEL OR EQUIVALENT</b>		<b>CATEGORY B - ENHANCED GALVANIZED OR EQUIVALENT</b>		
<b>Metal connectors:</b> <ul style="list-style-type: none"> <li>Stainless steel per ASTM A316</li> </ul>		<b>Metal connectors:</b> <ul style="list-style-type: none"> <li>Galvanized per ASTM A653 with G185 coating</li> <li>Hot-dip galvanized per ASTM A123</li> </ul>		
<b>Fasteners:</b> <ul style="list-style-type: none"> <li>Stainless steel per ASTM A304 or A316</li> <li>Proprietary coated fasteners require documentation of equivalent corrosion protection performance to stainless steel, such as equivalence testing per ICC-ES AC257 Exposure Condition 4, or other comparative testing documentation</li> </ul>		<b>Fasteners with diameters over 3/8 in.:</b> <ul style="list-style-type: none"> <li>Hot-dip galvanized per ASTM A153 Class C</li> </ul>		
<b>CATEGORY C - STANDARD GALVANIZED</b>		<b>Fasteners with diameters up to 3/8 in. shall meet one of the following:</b> <ul style="list-style-type: none"> <li>Hot-dip galvanized per ASTM A153 Class D</li> <li>Galvanized per ASTM A641 Class 3</li> <li>Per ASTM G85, Annex 5, Corrosion resistance exhibiting not more than 5% red rust after the following:                             <ul style="list-style-type: none"> <li>for nails: 280 hours</li> <li>for roof tile fasteners: 1000 hours</li> <li>for other carbon steel fasteners: 360 hours</li> </ul> </li> </ul>		
<b>Metal connectors:</b> <ul style="list-style-type: none"> <li>Galvanized per ASTM A653 with G90 coating</li> </ul>		<ul style="list-style-type: none"> <li>In lieu of testing listed above, proprietary coated fasteners require documentation of equivalent or superior corrosion protection performance to the galvanization options listed above, such as equivalence testing per ICC-ES AC257 Exposure Condition 4, or other comparative testing documentation</li> <li>Testing per ASTM B117 with corrosion resistance exhibiting not more than 5% red rust after 1,000 hours exposure may be accepted if no other testing is available</li> </ul>		
<b>Fasteners:</b> <ul style="list-style-type: none"> <li>Galvanized per ASTM A641 Class 1</li> </ul>				
<b>NOTES</b>				
1. For the purposes of FORTIFIED Home designation, "saltwater shoreline" shall be considered as the ocean or gulf coastline along the mainland United States including seaward island coastlines. This includes the Atlantic, Pacific, and Gulf of Mexico coastlines, as well as the coastline of any Bay or Sound with no land barrier separating it from being completely open to the ocean or Gulf of Mexico. Distances are measured from the closest feature of the subject building to the ocean or gulf coastline.				
2. Fastener and connector materials and coatings must be compatible with materials and coatings they come into contact with to prevent galvanic corrosion due to dissimilar materials.				
3. Fasteners in contact with chemically treated wood shall be in accordance with the requirements of the IBC/IRC or locally adopted code as applicable.				
Effective November 1, 2021				
<b>DESCRIPTION:</b> CORROSION PROTECTION REQUIREMENTS		<b>DRAWING #:</b> F-C-1		
<b>DATE:</b> 11/01/2021				

F-G-2

	<p><b>APPLICABLE STANDARDS:</b>          FORTIFIED HOME™ - HURRICANE (2020)          FORTIFIED HOME™ - HIGH WIND (2020)</p>	<p><b>DESCRIPTION:</b>          ROOF AND WALL ZONE DIAGRAM</p>	<p><b>DRAWING #:</b>          F-C-2</p> <p><b>DATE:</b>          11/01/2020</p>
<div style="display: flex; justify-content: space-between;"> <div style="width: 45%;"> <p><b>INTERIOR ZONES</b>              ROOFS - ZONE 1/ WALLS - ZONE 4</p> </div> <div style="width: 45%;"> <p><b>END ZONES</b>              ROOFS - ZONE 2/ WALLS - ZONE 5</p> </div> </div> <div style="display: flex; justify-content: space-around; margin-top: 10px;"> <div style="text-align: center;"> </div> <div style="text-align: center;"> </div> </div> <div style="display: flex; justify-content: space-around; margin-top: 10px;"> <div style="text-align: center;"> </div> <div style="text-align: center;"> </div> </div> <div style="margin-top: 20px;"> <p><b>CORNER ZONES</b>              ROOFS - ZONE 3</p> </div> <div style="margin-top: 20px;"> <p><b>GENERAL NOTES:</b>              1. REFER TO APPLICABLE FORTIFIED HOME STANDARDS FOR ADDITIONAL INFORMATION.              2. FORTIFIED HOME STANDARDS ARE TO BE APPLIED IN CONJUNCTION WITH FEDERAL, STATE, AND LOCAL CODES, ORDINANCES AND REGULATIONS IN ADDITION TO THE STRUCTURAL DESIGN WHICH IS BY OTHERS. IN CASE OF A CONFLICT BETWEEN PROVISIONS, USE WHICHEVER IS MORE STRINGENT.</p> </div> <div style="margin-top: 20px;"> </div>			

**F-RS-1**

**APPLICABLE STANDARDS:**

FORTIFIED HOME™ - HURRICANE (2020)  
FORTIFIED HOME™ - HIGH WIND (2020)

**DESCRIPTION:**

ROOF DECK ATTACHMENT - SAWN LUMBER OR WOOD BOARD ROOF DECK WITH NO GAPS

**DRAWING #:**

F-RS-1

**DATE:**

11/01/2020

**Table F-RS-1: FASTENERS REQUIRED FOR WOOD BOARD DECKING ATTACHMENT.**

WOOD BOARD/LUMBER (ROOF DECKING) WIDTH	NUMBER AND MINIMUM DIMENSIONS OF NAILS PER BOARD FOR EACH FRAMING MEMBER IT CROSSES
UP TO 8"	TWO(2) 0.131" Ø MIN. W/ 1 - 5/8" PENETRATION INTO ROOF FRAMING MEMBERS (MIN. LENGTH OF NAIL = 2 - 1/2")
LARGER THAN 8"	THREE(3) 0.131" Ø MIN. W/ 1 - 5/8" PENETRATION INTO ROOF FRAMING MEMBERS (MIN. LENGTH OF NAIL = 2 - 1/2")

NOTE: CLIPPED-HEAD, D-HEAD, OR ROUND-HEAD NAILS SHALL BE ACCEPTABLE PROVIDED THEY HAVE THE REQUIRED MINIMUM DIAMETER AND LENGTH.

**GENERAL NOTES:**

- REFER TO APPLICABLE FORTIFIED HOME STANDARDS FOR ADDITIONAL INFORMATION.
- REFER TO APPLICABLE FOR SHINGLE OR METAL ROOF COVERS.
- FORTIFIED HOME STANDARDS ARE TO BE APPLIED IN CONJUNCTION WITH FEDERAL, STATE, AND LOCAL CODES, ORDINANCES, AND REGULATIONS IN ADDITION TO THE STRUCTURAL DESIGN WHICH IS BY OTHERS. IN CASE OF A CONFLICT BETWEEN PROVISIONS, USE WHICHEVER IS MORE STRINGENT.

REFER TO TABLE F-RS-1 FOR REQUIRED SIZE AND NUMBER OF NAILS.

24" O.C. MAX.

BOARD WIDTH

MINIMUM 5/8" SAWN LUMBER OR WOOD BOARD ROOF DECK BY OTHERS.

ROOF FRAMING MEMBERS W/ 2" MIN. NOMINAL THICKNESS.



**F-RS-2**

- GENERAL NOTES:**
- REFER TO APPLICABLE FORTIFIED HOME STANDARDS FOR ADDITIONAL INFORMATION. FORTIFIED HOME STANDARDS ARE TO BE APPLIED IN CONJUNCTION WITH FEDERAL, STATE, AND LOCAL CODES, ORDINANCES AND REGULATIONS IN ADDITION TO THE STRUCTURAL DESIGN WHICH IS BY OTHERS. IN CASE OF A CONFLICT BETWEEN PROVISIONS, USE WHICHEVER IS MORE STRINGENT.

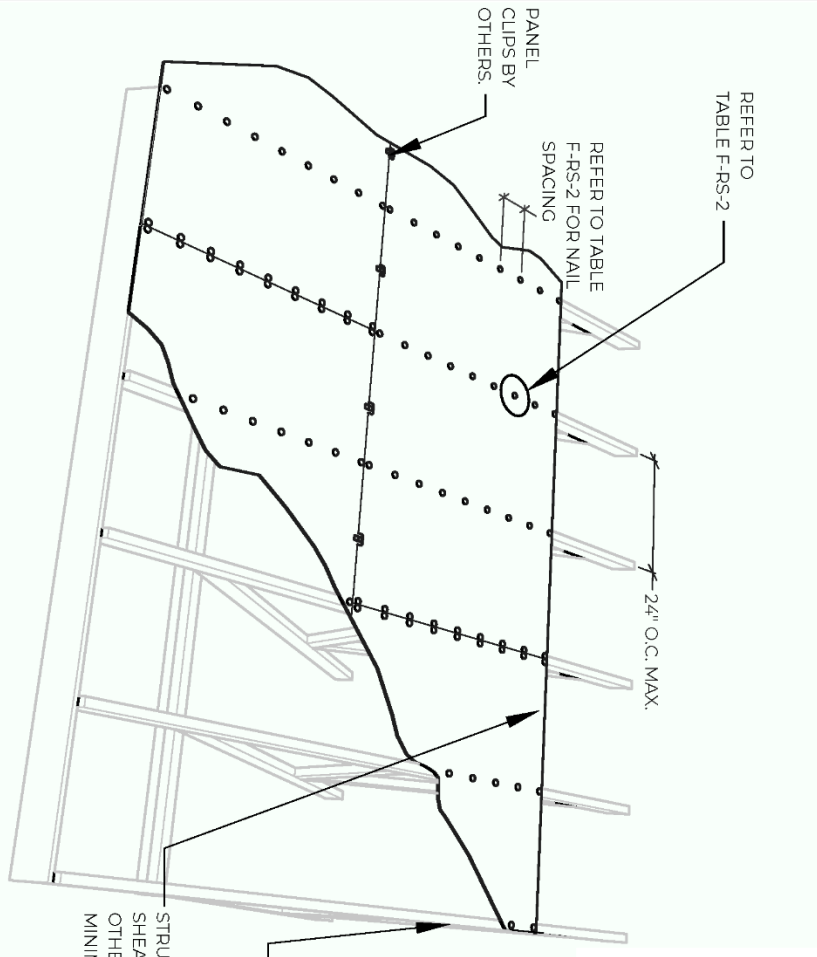

**TABLE F-RS-2: MINIMUM REQUIREMENTS FOR ROOF SHEATHING THICKNESS AND FASTENING**

ASCE Edition	Minimum Roof Sheathing Thickness <sup>1,2,3</sup>	Minimum Nail Size/Type <sup>1,4</sup>	Maximum Nail Spacing (All Roof Areas) <sup>1</sup>
ASCE 7-10	7/16"	See Notes 1, 2, 3	
ASCE 7-16	15/32"	RRRS-01, 0.113" dia. x 2-3/8" Roof Sheathing Ring Shank Nail	4" O.C.

- Notes:**
- Local building code requirements for roof sheathing thickness and/or nail size/attachment spacing may be more stringent based on site conditions.
  - For concrete and clay tile roof covers, minimum required sheathing thickness is 15/32".
  - For metal roof covers, verify manufacturer's sheathing thickness requirements are met.
  - Full round head  $\phi$ ; No clipped-head nails, common nails or staples shall be allowed. Refer to Figure 1.

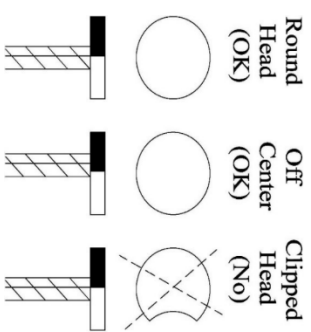

**FIGURE 1.**

	<b>APPLICABLE STANDARDS:</b>	<b>DESCRIPTION:</b>	<b>DRAWING #:</b>
	FORTIFIED HOME™ - HURRICANE (2020)		
			<b>DATE:</b>
			7/10/2020



**F-RS-3**

- GENERAL NOTES:**  
 REFER TO APPLICABLE FORTIFIED HOME STANDARDS FOR ADDITIONAL INFORMATION.  
 1. TO BE ELIGIBLE FOR COLD DESIGNATION, ROOF MEMBERS MUST BE DESIGNED FOR MINIMUM VULT = 130 MPH DESIGN WIND LOADS AND TERRAIN EXPOSURE C.  
 2. FORTIFIED HOME STANDARDS ARE TO BE APPLIED IN CONJUNCTION WITH FEDERAL, STATE, AND LOCAL CODES, ORDINANCES AND REGULATIONS IN ADDITION TO THE STRUCTURAL DESIGN WHICH IS BY OTHERS. IN CASE OF A CONFLICT BETWEEN PROVISIONS, USE WHICHEVER IS MORE STRINGENT.  
 3. ROOF FRAMING MEMBERS W/ 2" MIN. NOMINAL THICKNESS. REFER TO GENERAL NOTE #3.

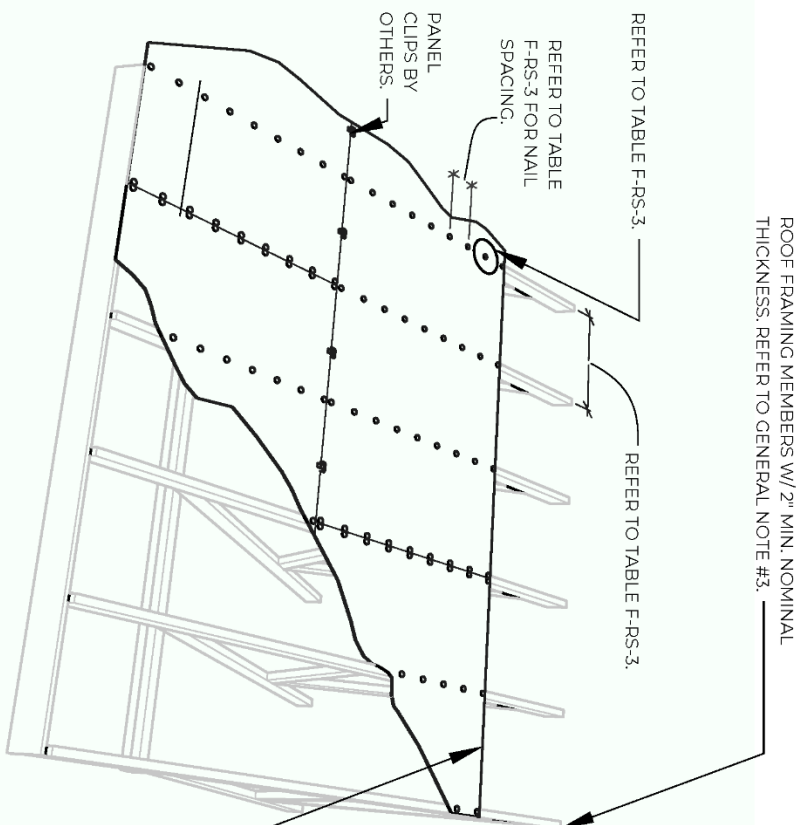

**Table F-RS-3: MINIMUM REQUIREMENTS FOR ROOF SHEATHING THICKNESS AND FASTENING**

ASCE Edition	Minimum Roof Sheathing Thickness <sup>1,2,3</sup>			Minimum Nail Size/Type <sup>1,4</sup>	Maximum Nail Spacing (All Roof Areas) <sup>5</sup>
	Roof members @ 16" O.C. Max.	Roof Members @ 24" O.C. Max.	Roof Members @ 24" O.C. Max.		
ASCE 7-10	3/8" See Notes 1, 2, 3	7/16" See Notes 1, 2, 3	7/16" See Notes 1, 2, 3	RSRS-01: 0.113" dia. x 2-3/8" Roof Sheathing Ring Shank Nail	6" O.C.
ASCE 7-16	3/8" See Notes 1, 2, 3	7/16" See Notes 1, 2, 3	15/32" See Notes 1, 3	RSRS-01: 0.113" dia. x 2-3/8" Roof Sheathing Ring Shank Nail Common Nails Not an Option	4" O.C.

- NOTES:**  
 1. Local building code requirements for sheathing thickness and/or nail size/attachment spacing may be more stringent based on site conditions.  
 2. For concrete and clay tile roof covers, minimum required sheathing thickness is 15/32".  
 3. For metal roof covers, verify manufacturer's sheathing thickness requirements are met.  
 4. Full round head Ø. No clipped-head nails, common nails or staples shall be allowed. Refer to Figure 1.  
 5. For structural wood panel roof sheathing (plywood or OSB) by others, refer to Table F-RS-3 for minimum thickness requirements.

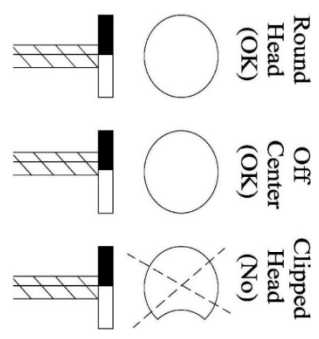

**FIGURE 1.**

	<b>APPLICABLE STANDARDS:</b> FORTIFIED HOME™ - HIGH WIND (2020)	<b>DESCRIPTION:</b> HIGH WIND - NEW CONSTRUCTION ROOF DECK ATTACHMENT - STRUCTURAL WOOD PANELS	<b>DRAWING #:</b> F-RS-3
			<b>DATE:</b> 11/01/2020

**F-SRD-1**

	<p><b>APPLICABLE STANDARDS:</b> FORTIFIED HOME™ - HURRICANE (2020) FORTIFIED HOME™ - HIGH WIND (2020)</p>	<p><b>DESCRIPTION:</b> STEEP SLOPE ROOF DECK ATTACHMENT AND SEALED ROOF DECK FROM WITHIN USING SPRAY FOAM</p>	<p><b>DRAWING #:</b> F-SRD-1</p> <p><b>DATE:</b> 11/01/2020</p>
<div style="display: flex; justify-content: space-between;"> <div style="width: 45%;"> <p><b>5. USE THE MINIMUM DENSITY AND INSTALLATION REQUIREMENTS PRESCRIBED BY THE MANUFACTURER TO MEET A MINIMUM DESIGN UPLIFT PRESSURE ON THE SHEATHING OF 110 PSF FOR HURRICANE OR 80 PSF FOR HIGH WIND.</b></p> </div> <div style="width: 50%;"> <ol style="list-style-type: none"> <li>1. MINIMUM REQUIREMENTS FOR SPRAY ADHESIVES: PRODUCT MUST BE TESTED AND EVALUATED IN ACCORDANCE WITH EITHER ASTM E330, STANDARD TEST METHOD FOR STRUCTURAL PERFORMANCE OF EXTERIOR WINDOWS, DOORS, SKYLIGHTS, AND CURTAIN WALLS BY UNIFORM STATIC AIR PRESSURE DIFFERENCE (APPLIED TO ROOF SHEATHING) OR TAS 202-94, CRITERIA FOR TESTING IMPACT AND NON-IMPACT RESISTANT BUILDING ENVELOPE COMPONENTS USING UNIFORM STATIC AIR PRESSURE. THE MINIMUM ALLOWABLE DESIGN UPLIFT PRESSURE MUST BE GREATER THAN OR EQUAL TO 110 PSF AND THE PROOF TEST PRESSURE ACHIEVED WITHOUT FAILURE OR STRUCTURAL DISTRESS MUST BE GREATER THAN OR EQUAL TO 165 PSF.</li> <li>2. ADHESIVE MUST BE A TWO-COMPONENT SPRAY POLYURETHANE FOAM SYSTEM WITH A MINIMUM CORE DENSITY OF 1.5-3.0 PCF IN ACCORDANCE WITH ASTM D1622, STANDARD TEST METHOD FOR APPARENT DENSITY OF RIGID CELLULAR PLASTICS.</li> <li>3. SPRAY POLYURETHANE FOAM ADHESIVE SYSTEM MUST BE INSTALLED BY A PROPERLY TRAINED AND QUALIFIED APPLICATOR IN ACCORDANCE WITH THE MANUFACTURERS MAINTENANCE AND INSTALLATION GUIDELINES.</li> <li>4. DOCUMENTATION FROM THE INSTALLING CONTRACTOR, ON COMPANY LETTERHEAD, IDENTIFYING THE MANUFACTURER AND PRODUCT USED FOR THE IMPROVED ROOF SHEATHING ATTACHMENT/SEALED ROOF DECK MUST BE PROVIDED TO THE CERTIFIED FORTIFIED EVALUATOR TO BE INCLUDED WITH FINAL DESIGNATION CHECKLIST. DOCUMENTATION SHOULD ALSO STATE THAT THE INSTALLATION MEETS THE MANUFACTURERS REQUIREMENTS FOR AN ALLOWABLE DESIGN UPLIFT PRESSURE OF AT LEAST 110 PSF (PROOF TEST OF AT LEAST 165 PSF).</li> </ol> </div> </div> <div style="margin-top: 20px;"> <p><b>GENERAL NOTES:</b> REFER TO APPLICABLE FORTIFIED HOME STANDARDS FOR ADDITIONAL INFORMATION. EXISTING SHEATHING REQUIREMENTS: FOR HURRICANE: 7/16" MIN. THICKNESS REQUIRED WITH ROOF MEMBERS @ 24" O.C. MAX. FOR HIGH WIND: 7/16" MIN. THICKNESS IS REQUIRED FOR GOLD DESIGNATION, FOR ROOF/SILVER DESIGNATION, 3/8" MIN. THICKNESS IS PERMITTED WHEN ROOF MEMBERS ARE 16" O.C. MAX. FORTIFIED HOME STANDARDS ARE TO BE APPLIED IN CONJUNCTION WITH FEDERAL, STATE, AND LOCAL CODES, ORDINANCES AND REGULATIONS IN ADDITION TO THE STRUCTURAL DESIGN WHICH IS BY OTHERS. IN CASE OF A CONFLICT BETWEEN PROVISIONS, USE WHICHEVER IS MORE STRINGENT.</p> </div> <div style="margin-top: 20px;"> <p><b>UNDERSIDE OF ROOF DECK FROM WITHIN ATTIC</b></p> <p>15" TO 3" FILLET OF 2-PART SPRAY-APPLIED CLOSED CELL POLYURETHANE FOAM ADHESIVE AT ALL JOINTS BETWEEN SHEATHING AND AT ALL INTERSECTIONS BETWEEN ROOF SHEATHING AND ROOF FRAMING MEMBERS, AND AT ALL VALLEYS. REFER TO MINIMUM REQUIREMENTS FOR SPRAY ADHESIVES.</p> <p>EXISTING STRUCTURAL WOOD PANEL ROOF SHEATHING BY OTHERS. REFER TO GENERAL NOTE #2 FOR REQUIREMENTS.</p> </div>			

**F-SRD-2**

	<p><b>APPLICABLE STANDARDS:</b>          FORTIFIED HOME™ - HURRICANE (2020)          FORTIFIED HOME™ - HIGH WIND (2020)</p>	<p><b>DESCRIPTION:</b>          STEEP SLOPE SEALED ROOF DECK - FLASHING TAPE AND UNDERLAYMENT - SHINGLE OR METAL ROOF COVERS</p>	<p><b>DRAWING #:</b>          F-SRD-2</p> <p><b>DATE:</b>          11/01/2020</p>
<p><b>GENERAL NOTES:</b></p> <ol style="list-style-type: none"> <li>REFER TO APPLICABLE FORTIFIED HOME STANDARDS FOR ADDITIONAL INFORMATION.</li> <li>REFER TO FORTIFIED STANDARD DETAIL F-G-1 FOR CORROSION PROTECTION REQUIREMENTS.</li> <li>APPLICABLE FOR ROOF PITCH 2:12 OR GREATER.</li> <li>NAILS USED TO ATTACH UNDERLAYMENT SHALL BE ANNULAR RING OR DEFORMED SHANK ROOFING NAILS W/ 0.083" MINIMUM DIAMETER AND SUFFICIENT LENGTH TO PENETRATE THROUGH THE ROOF SHEATHING OR NOT LESS THAN 3/4" INTO THE ROOF SHEATHING W/ 1" DIAMETER BUTTON CAPS (METAL BUTTON CAPS ARE REQUIRED FOR ULTIMATE DESIGN WIND SPEED OF 160 MPH OR GREATER).</li> <li>FORTIFIED HOME STANDARDS ARE TO BE APPLIED IN CONJUNCTION WITH FEDERAL, STATE, AND LOCAL CODES, ORDINANCES AND REGULATIONS. IN ADDITION TO THE STRUCTURAL DESIGN WHICH IS BY OTHERS, IN CASE OF A CONFLICT BETWEEN PROVISIONS, USE WHICHEVER IS MORE STRINGENT.</li> </ol> <p>FLASHING TAPE AT ALL PANEL SEAMS FULLY ADHERED W/ NO WRINKLES OR VOIDS USING ROLLER.</p> <p><b>MATERIAL OPTION 1:</b> 4" WIDE ASTM D1970 COMPLIANT SELF-ADHERING POLYMER - MODIFIED BITUMEN FLASHING TAPE.</p> <p><b>MATERIAL OPTION 2:</b> 3 - 3/4" WIDE AAMA 711-13 LEVEL 3 (FOR EXPOSURE UP TO 80°C/176°F) COMPLIANT SELF-ADHERING FLASHING TAPE.</p> <p>ASTM D226 TYPE II #30 OR ASTM D4869 TYPE III OR TYPE IV #30 UNDERLAYMENT. (FOR ASPHALT SHINGLE ROOF COVERS, ASTM D6757 UNDERLAYMENT IS ALSO ACCEPTABLE)</p> <p>ALL REINFORCED SYNTHETIC ROOF UNDERLAYMENT WITH ICC APPROVAL AS ASTM D226 TYPE II:</p> <p>MINIMUM TEAR STRENGTH = 15 LBF PER ASTM D4533</p> <p>MINIMUM TENSILE STRENGTH = 20 PSF PER ASTM D5035</p> <p>PASS ASTM D4869 SHOWER TEST.</p> <p>HORIZONTAL LAPS = 4" MIN.          END LAPS = 6" MIN.</p> <p>HOLD BACK BUTTON CAPS AT EDGES TO AVOID INSTALLING DRIP EDGE OVER BUTTON CAPS. REFER TO F-DE-1 AND/OR F-DE-3 FOR DRIP EDGE INSTALLATION.</p> <p>ROOF SHEATHING; REFER TO FORTIFIED STANDARD DETAILS F-RS-1, F-RS-2, AND F-RS-3.</p> <p>6" MIN. OVERLAP FOLDED OVER RIDGE ON BOTH SIDES.</p> <p>4" MIN. (TYP)</p> <p>12" O.C. (MAX)</p> <p>12" O.C. (MAX)</p> <p>6" O.C. (MAX)</p> <p>6" END LAPS (TYP)</p> <p><b>NOTE:</b> 36" WIDE SHEET SHOWN, FOR WIDER SHEETS, ADDITIONAL ROW(S) OF NAILS WILL BE NEEDED.</p> <p>REFER TO GENERAL NOTE # 4. NAILS SPACED AS SHOWN OR A MORE STRINGENT FASTENER SCHEDULE IF REQUIRED BY MANUFACTURER. 6" O.C. ON ALL SIDES AND END LAPS. 12" O.C. MAX. BOTH HORIZONTALLY AND VERTICALLY BETWEEN END LAPS.</p>			

**F-SRD-3**

	<p><b>APPLICABLE STANDARDS:</b>          FORTIFIED HOME™ - HURRICANE (2020)          FORTIFIED HOME™ - HIGH WIND (2020)</p>	<p><b>DESCRIPTION:</b>          STEEP SLOPE SEALED ROOF DECK -          TWO LAYERS FELT UNDERLAYMENT -          SHINGLE OR METAL ROOF COVERS</p>	<p><b>DRAWING #:</b>          F-SRD-3</p> <p><b>DATE:</b>          11/01/2020</p>
<p><b>GENERAL NOTES:</b></p> <ol style="list-style-type: none"> <li>REFER TO APPLICABLE FORTIFIED HOME STANDARDS FOR ADDITIONAL INFORMATION.</li> <li>REFER TO FORTIFIED STANDARD DETAIL F-G-1 FOR CORROSION PROTECTION REQUIREMENTS.</li> <li>WEAVE UNDERLAYMENT ACROSS VALLEYS.</li> <li>DOUBLE LAP UNDERLAYMENT ACROSS RIDGES (UNLESS THERE IS A CONTINUOUS RIDGE VENT).</li> <li>LAP UNDERLAYMENT WITH MINIMUM 6" LEG-UP TURNED UP" AT WALL INTERSECTIONS; LAP WALL WEATHER BARRIER OVER TURNED-UP ROOF UNDERLAYMENT.</li> <li>APPLICABLE FOR ROOF PITCH 2:12 OR GREATER.</li> <li>NAILS USED TO ATTACH UNDERLAYMENT SHALL BE ANNULAR RING OR DEFORMED SHANK ROOFING NAILS W/ 0.083" MINIMUM DIAMETER AND SUFFICIENT LENGTH TO PENETRATE THROUGH THE ROOF SHEATHING OR NOT LESS THAN 3/4" INTO THE ROOF SHEATHING W/ 1" DIAMETER BUTTON CAPS (METAL BUTTON CAPS ARE REQUIRED FOR ULTIMATE DESIGN WIND SPEED OF 160 MPH OR GREATER).</li> <li>FORTIFIED HOME STANDARDS ARE TO BE APPLIED IN CONJUNCTION WITH FEDERAL, STATE, AND LOCAL CODES, ORDINANCES AND REGULATIONS IN ADDITION TO THE STRUCTURAL DESIGN WHICH IS BY OTHERS. IN CASE OF A CONFLICT BETWEEN PROVISIONS, USE WHICHEVER IS MORE STRINGENT.</li> <li>ROOF SHEATHING BY OTHERS; REFER TO FORTIFIED STANDARD DETAILS F-RS-1, F-RS-2, AND F-RS-3.</li> </ol> <p>ASTM D226 TYPE II #30 OR ASTM D4869 TYPE III OR TYPE IV #30 UNDERLAYMENT LAPPED AS SHOWN. (FOR ASPHALT SHINGLE ROOF COVERS, ASTM D6757 UNDERLAYMENT IS ALSO ACCEPTABLE)</p> <p>6" MIN. OVERLAP FOLDED OVER RIDGE ON BOTH SIDES</p> <p>6" O.C. @ END LAPS</p> <p>6" O.C. @ END LAPS</p> <p>6" END LAPS (TYP.)</p> <p>EQ EQ</p> <p>19"</p> <p>17"</p> <p>17"</p> <p>19"</p> <p>36"</p> <p>2" (TYP.)</p> <p>6" O.C. (MAX.)</p> <p>12" O.C. (MAX.)</p> <p>19" STARTER SHEET TACKED IN PLACE W/ ROOFING NAILS.</p> <p>REFER TO GENERAL NOTE #7. NAILS SPACED AS SHOWN.</p> <p>HOLD BACK BUTTON CAPS AT EDGES TO AVOID INSTALLING DRIP EDGE OVER BUTTON CAPS; REFER TO F-DE-1 AND/OR F-DE-3 FOR DRIP EDGE INSTALLATION.</p>			

**F-SRD-4**

	<p><b>APPLICABLE STANDARDS:</b></p> <p>FORTIFIED HOME™ - HURRICANE (2020)          FORTIFIED HOME™ - HIGH WIND (2020)</p>	<p><b>DESCRIPTION:</b></p> <p>STEEP SLOPE SEALED ROOF DECK - SELF-ADHERED MEMBRANE (SHOWING BOND BREAK FOR ASPHALT SHINGLES) - SHINGLE AND METAL ROOF COVERS</p>	<p><b>DRAWING #:</b></p> <p>F-SRD-4</p> <p><b>DATE:</b></p> <p>11/01/2020</p>
<div style="display: flex; justify-content: space-between;"> <div style="width: 45%;"> <p>GENERAL NOTES:</p> <ol style="list-style-type: none"> <li>1. REFER TO APPLICABLE FORTIFIED HOME STANDARDS FOR ADDITIONAL INFORMATION.</li> <li>2. APPLICABLE FOR ROOF PITCH 2:12 OR GREATER.</li> <li>3. REFER TO AND INSTALL IN ACCORDANCE WITH MANUFACTURER SPECIFICATIONS AND INSTALLATION INSTRUCTIONS. REFER TO PRODUCT APPROVAL TO VERIFY REQUIRED WIND PRESSURES ARE MET IF APPLICABLE.</li> <li>4. ADEQUATE ATTIC VENTILATION IS REQUIRED. REFER TO UNDERLAYMENT AND PRIMARY ROOF SYSTEM MANUFACTURERS' INSTALLATION INSTRUCTIONS FOR VENTILATION LIMITATIONS. ALSO CHECK WITH LOCAL BUILDING CODES FOR RESTRICTIONS.</li> <li>5. FORTIFIED HOME STANDARDS ARE TO BE APPLIED IN CONJUNCTION WITH FEDERAL, STATE, AND LOCAL CODES, ORDINANCES AND REGULATIONS IN ADDITION TO THE STRUCTURAL DESIGN WHICH IS BY OTHERS. IN CASE OF A CONFLICT BETWEEN PROVISIONS, USE WHICHEVER IS MORE STRINGENT.</li> </ol> <p>ROOF SHEATHING: REFER TO FORTIFIED STANDARD DETAILS F-RS-1, F-RS-2, AND F-RS-3. APPLY MANUFACTURER-SPECIFIED COMPATIBLE PRIMER TO ROOF SHEATHING PER MANUFACTURER INSTALLATION INSTRUCTIONS.</p> <p>4" MIN. SIDELAPS OR GREATER IF SPECIFIED BY MANUFACTURERS' SPECIFICATIONS AND INSTALLATION INSTRUCTIONS.</p> </div> <div style="width: 45%; text-align: right;"> <p>ASTM D1970 SELF-ADHERING, POLYMER-MODIFIED BITUMEN MEMBRANE COVERING ENTIRE ROOF DECK. REFER TO GENERAL NOTES #3 AND #4.</p> <p>REFER TO MANUFACTURER'S SPECIFICATIONS FOR REQUIRED OVERLAP AND FOLLOW INSTALLATION INSTRUCTIONS.</p> <p>STAGGER AND INSTALL END LAPPS AS SPECIFIED PER MANUFACTURER'S SPECIFICATIONS AND INSTALLATION INSTRUCTIONS.</p> <p>FASTENED ADEQUATELY TO KEEP IN PLACE UNTIL ROOF COVERING IS APPLIED.</p> <p><b>OPTIONAL FOR ASPHALT SHINGLES.</b> APPLY #15 ASTM D226 TYPE I UNDERLAYMENT AS BOND BREAK HELD BACK 8" FROM ROOF EDGES OVER ENTIRE ROOF.</p> </div> </div>			



**F-SRD-5**

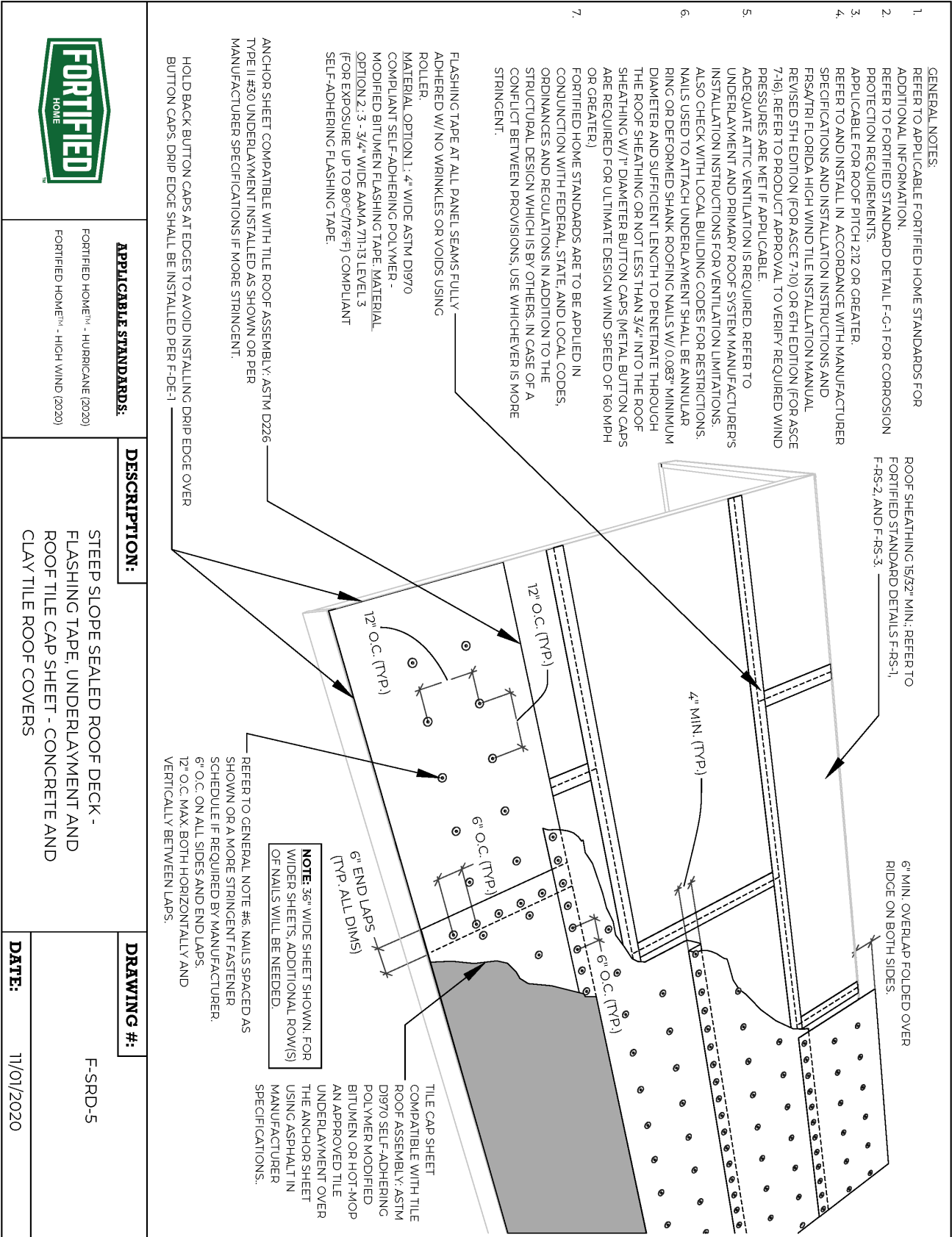

1. GENERAL NOTES:  
REFER TO APPLICABLE FORTIFIED HOME STANDARDS FOR ADDITIONAL INFORMATION.
2. REFER TO FORTIFIED STANDARD DETAIL F-C-1 FOR CORROSION PROTECTION REQUIREMENTS.
3. APPLICABLE FOR ROOF PITCH 2:12 OR GREATER.  
REFER TO AND INSTALL IN ACCORDANCE WITH MANUFACTURER SPECIFICATIONS AND INSTALLATION INSTRUCTIONS AND FSAATFL FLORIDA HIGH WIND TILE INSTALLATION MANUAL REVISED 5TH EDITION (FOR ASCE 7-10) OR 6TH EDITION (FOR ASCE 7-16). REFER TO PRODUCT APPROVAL TO VERIFY REQUIRED WIND PRESSURES ARE MET IF APPLICABLE.
5. ADEQUATE ATTIC VENTILATION IS REQUIRED. REFER TO UNDERLAYMENT AND PRIMARY ROOF SYSTEM MANUFACTURERS INSTALLATION INSTRUCTIONS FOR VENTILATION LIMITATIONS.  
ALSO CHECK WITH LOCAL BUILDING CODES FOR RESTRICTIONS.  
NAILS USED TO ATTACH UNDERLAYMENT SHALL BE ANNULAR RING OR DEFORMED SHANK ROOFING NAILS W/ 0.083" MINIMUM DIAMETER AND SUFFICIENT LENGTH TO PENETRATE THROUGH THE ROOF SHEATHING OR NOT LESS THAN 3/4" INTO THE ROOF SHEATHING W/ 1" DIAMETER BUTTON CAPS (METAL BUTTON CAPS ARE REQUIRED FOR ULTIMATE DESIGN WIND SPEED OF 160 MPH OR GREATER)
6. FORTIFIED HOME STANDARDS ARE TO BE APPLIED IN CONJUNCTION WITH FEDERAL, STATE, AND LOCAL CODES, ORDINANCES AND REGULATIONS IN ADDITION TO THE STRUCTURAL DESIGN WHICH IS BY OTHERS. IN CASE OF A CONFLICT BETWEEN PROVISIONS, USE WHICHEVER IS MORE STRINGENT.
7. FLASHING TAPE AT ALL PANEL SEAMS FULLY ADHERED W/ NO WRINKLES OR Voids USING ROLLER.  
MATERIAL OPTION 1: 4" WIDE ASTM D1970 COMPLIANT SELF-ADHERING POLYMER - MODIFIED BITUMEN FLASHING TAPE MATERIAL OPTION 2: 3 - 3/4" WIDE AAMA 711-13 LEVEL 3 (FOR EXPOSURE UP TO 80°C/176°F) COMPLIANT SELF-ADHERING FLASHING TAPE.

	<p><b>APPLICABLE STANDARDS:</b> FORTIFIED HOME™ - HURRICANE (2020) FORTIFIED HOME™ - HIGH WIND (2020)</p>	<p><b>DESCRIPTION:</b> STEEP SLOPE SEALED ROOF DECK - FLASHING TAPE, UNDERLAYMENT AND ROOF TILE CAP SHEET - CONCRETE AND CLAY TILE ROOF COVERS</p>	<p><b>DRAWING #:</b> F-SRD-5</p> <p><b>DATE:</b> 11/01/2020</p>
--	---	--	---



**F-SRD-6**

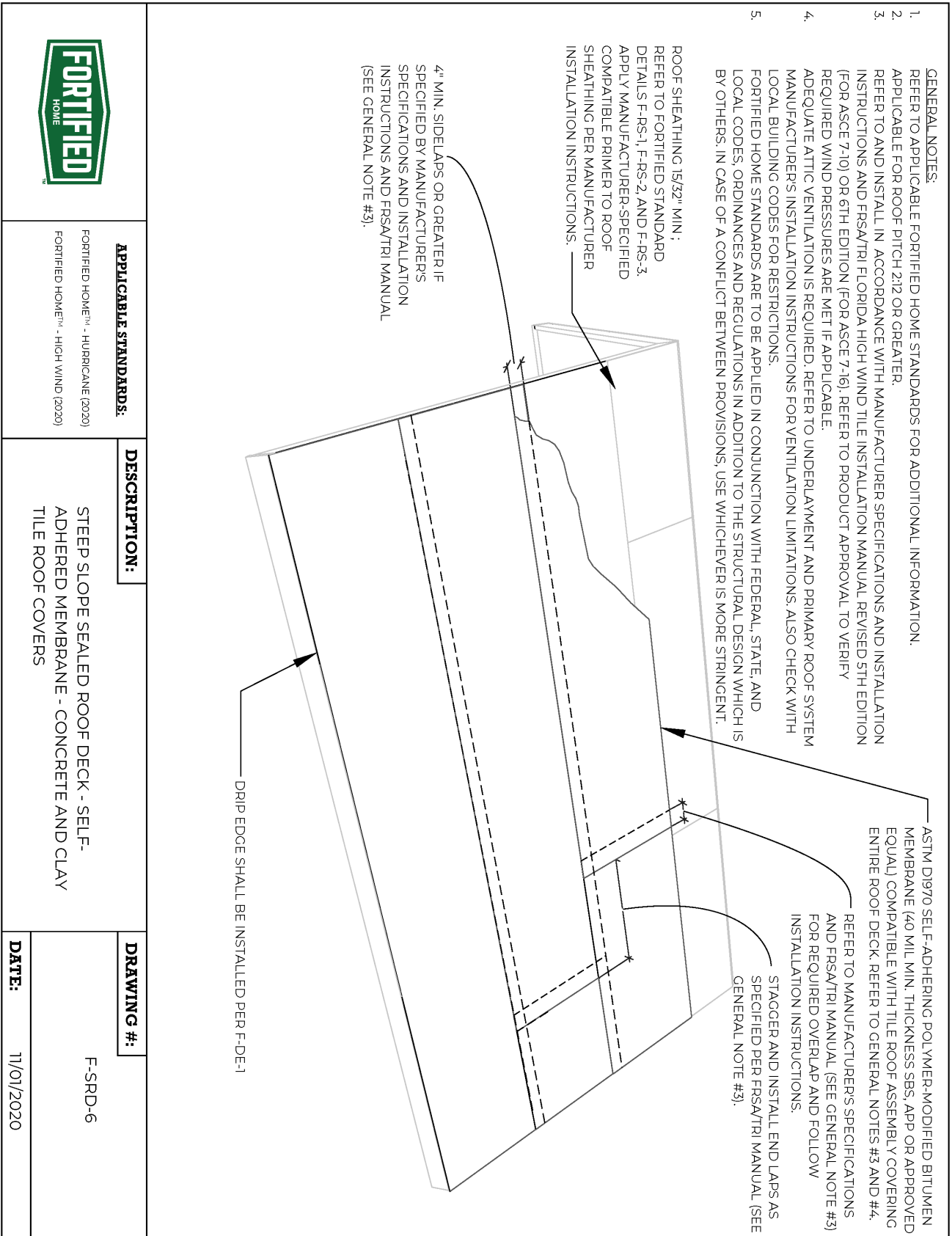

	<p><b>APPLICABLE STANDARDS:</b></p> <p>FORTIFIED HOME™ - HURRICANE (2020)          FORTIFIED HOME™ - HIGH WIND (2020)</p>	<p><b>DESCRIPTION:</b></p> <p>STEEP SLOPE SEALED ROOF DECK - SELF-ADHERED MEMBRANE - CONCRETE AND CLAY TILE ROOF COVERS</p>	<p><b>DRAWING #:</b></p> <p>F-SRD-6</p> <p><b>DATE:</b></p> <p>11/01/2020</p>
--	---	---	---

**F-DE-1**

	<p><b>APPLICABLE STANDARDS:</b></p> <p>FORTIFIED HOME™ - HURRICANE (2020)</p>	<p><b>DESCRIPTION:</b></p> <p>HURRICANE - DRIP EDGE INSTALLATION OVER UNDERLAYMENT</p>	<p><b>DRAWING #:</b></p> <p>F-DE-1</p>
		<p><b>GENERAL NOTES:</b></p> <ol style="list-style-type: none"> <li>1. REFER TO APPLICABLE FORTIFIED HOME STANDARDS FOR ADDITIONAL INFORMATION. REFER TO FORTIFIED STANDARD DETAIL F-G-1 FOR CORROSION PROTECTION REQUIREMENTS. BEST PRACTICES TO SEAL THE DRIP EDGE, SHINGLE ROOF COVERS, SEAL THE DRIP EDGE, UNDERLAYMENT AND STARTER STRIP AT THE EAVE BY EITHER USING A SELF-ADHERING STARTER STRIP OR APPLYING AN 8" WIDE LAYER OF COMPATIBLE FLASHING CEMENT WITH 1/8" MAX. THICKNESS OVER THE DRIP EDGE AND UNDERLAYMENT.</li> <li>2. FOR METAL ROOF COVERS, APPLY A COMPATIBLE MANUFACTURER-APPROVED SEALANT BETWEEN THE DRIP EDGE AND ADJACENT UNDERLAYMENT TO PREVENT WATER FROM ACCUMULATING UNDER THE DRIP EDGE OR USE A MANUFACTURER-APPROVED 4" SELF-ADHERED SEAM TAPE.</li> <li>3. APPLICABLE FOR ROOF PITCH 2:12 OR GREATER. FOR ROOF SLOPES LESS THAN 2:12, REFER TO MANUFACTURERS DRIP EDGE INSTALLATION REQUIREMENTS.</li> <li>4. FORTIFIED HOME STANDARDS ARE TO BE APPLIED IN CONJUNCTION WITH FEDERAL, STATE, AND LOCAL CODES, ORDINANCES AND REGULATIONS IN ADDITION TO THE STRUCTURAL DESIGN WHICH IS BY OTHERS. IN CASE OF A CONFLICT BETWEEN PROVISIONS, USE WHICHEVER IS MORE STRINGENT.</li> <li>5. METAL DRIP EDGE (MINIMUM 26 GAUGE FOR STEEL) ALONG ALL EAVES AND GABLE RAKE EDGES INSTALLED OVER UNDERLAYMENT. MAKE SURE THE TOP SURFACE OF THE DRIP EDGE IS CLEAN, FREE OF OIL, AND IF REQUIRED BY THE STARTER STRIP MANUFACTURER, PRIMED WITH ASTM D41 PRIMER. FOR SEALING THE DRIP EDGE REFER TO GENERAL NOTE #3.</li> </ol>	<p><b>DATE:</b></p> <p>11/01/2020</p>

(2) NAILS @ OVERLAPS

3" MIN. OVERLAP

4" O.C. MAX. STAGGERED

2" MIN.

UNDERLAYMENT INSTALLED IN ACCORDANCE WITH FORTIFIED STANDARD DETAILS F-SRD-2, F-SRD-3, F-SRD-4, OR F-SRD-5.

DRIP EDGE FLANGE SHALL EXTEND 1/2" MIN. BELOW SHEATHING

**F-DE-3**

	<p><b>APPLICABLE STANDARDS:</b> FORTIFIED HOME™ - HIGH WIND (2020)</p>	<p><b>DESCRIPTION:</b> HIGH WIND - DRIP EDGE INSTALLATION OVER UNDERLAYMENT</p>	<p><b>DRAWING #:</b> F-DE-3</p> <p><b>DATE:</b> 11/01/2020</p>
<p><b>GENERAL NOTES:</b></p> <ol style="list-style-type: none"> <li>REFER TO APPLICABLE FORTIFIED HOME STANDARDS FOR ADDITIONAL INFORMATION. REFER TO FORTIFIED STANDARD DETAIL F-G-1 FOR CORROSION PROTECTION REQUIREMENTS. BEST PRACTICES TO SEAL THE DRIP EDGE: SHINGLE ROOF COVERS; SEAL THE DRIP EDGE, UNDERLAYMENT AND STARTER STRIP AT THE EAVE BY EITHER USING A SELF-ADHERING STARTER STRIP OR APPLYING AN 8" WIDE LAYER OF COMPATIBLE FLASHING CEMENT WITH 1/8" MAX. THICKNESS OVER THE DRIP EDGE AND UNDERLAYMENT.</li> <li>FOR METAL ROOF COVERS; APPLY A COMPATIBLE MANUFACTURER-APPROVED SEALANT BETWEEN THE DRIP EDGE AND ADJACENT UNDERLAYMENT TO PREVENT WATER FROM ACCUMULATING UNDER THE DRIP EDGE OR USE A MANUFACTURER APPROVED 4" SELF-ADHERED SEAM TAPE.</li> <li>APPLICABLE FOR ROOF PITCH 2:12 OR GREATER. FOR ROOF SLOPES LESS THAN 2:12, REFER TO MANUFACTURERS DRIP EDGE INSTALLATION REQUIREMENTS.</li> <li>FORTIFIED HOME STANDARDS ARE TO BE APPLIED IN CONJUNCTION WITH FEDERAL, STATE, AND LOCAL CODES, ORDINANCES AND REGULATIONS IN ADDITION TO THE STRUCTURAL DESIGN WHICH IS BY OTHERS. IN CASE OF A CONFLICT BETWEEN PROVISIONS, USE WHICHEVER IS MORE STRINGENT.</li> <li>METAL DRIP EDGE (MINIMUM 26 GAUGE FOR STEEL) ALONG ALL EAVES AND GABLE RAKE EDGES INSTALLED OVER UNDERLAYMENT. MAKE SURE THE TOP SURFACE OF THE DRIP EDGE IS CLEAN, FREE OF OIL, AND IF REQUIRED BY THE STARTER STRIP MANUFACTURER, PRIMED WITH ASTM D41 PRIMER. FOR SEALING THE DRIP EDGE REFER TO GENERAL NOTE #3.</li> </ol> <p>UNDERLAYMENT INSTALLED IN ACCORDANCE WITH FORTIFIED STANDARD DETAILS F-SRD-2, F-SRD-3, F-SRD-4, OR F-SRD-5.</p> <p>(2) NAILS @ OVERLAPS</p> <p>3" MIN. OVERLAP</p> <p>12" O.C. MAX. STAGGERED. 4" O.C. MAX. FOR TILE ROOF COVERS</p> <p>2" MIN.</p> <p>DRIP EDGE FLANGE SHALL EXTEND 1/2" MIN. BELOW SHEATHING</p>			

**F-RC-1**

	<b>APPLICABLE STANDARDS:</b> FORTIFIED HOME™ - HURRICANE (2020) FORTIFIED HOME™ - HIGH WIND (2020)	<b>DESCRIPTION:</b> ASPHALT SHINGLE INSTALLATION GUIDANCE FOR STEEP SLOPE - OPTION 1: PEEL AND STICK STARTER STRIP INSTALLATION AT EAVE OR RAKE	<b>DRAWING #:</b> F-RC-1
<b>GENERAL NOTES:</b> REFER TO APPLICABLE FORTIFIED HOME STANDARDS FOR ADDITIONAL INFORMATION. 1. SHINGLES INSTALLED AT ALL INTERSECTIONS AND BOTH SIDES OF OPEN VALLEYS SHALL BE SET IN A MINIMUM 8 IN. WIDE STRIP OF FLASHING CEMENT (MAX. THICKNESS OF FLASHING CEMENT = 1/8"). CUT SIDE OF CLOSED VALLEYS SHALL BE SET IN A MINIMUM 2 IN. WIDE, 1/8" THICK STRIP OF FLASHING CEMENT. WOVEN VALLEYS TO BE ACCORDING TO THE MANUFACTURER'S SPECIFICATIONS. 2. REFER TO FORTIFIED STANDARD DETAILS F-RC-2 AND F-RC-3 FOR ADDITIONAL ASPHALT SHINGLE INSTALLATION OPTIONS. FORTIFIED HOME STANDARDS ARE TO BE APPLIED IN CONJUNCTION WITH FEDERAL, STATE, AND LOCAL CODES, ORDINANCES AND REGULATIONS IN ADDITION TO THE STRUCTURAL DESIGN WHICH IS BY OTHERS. IN CASE OF A CONFLICT BETWEEN PROVISIONS, USE WHICHEVER IS MORE STRINGENT. 3. UNDERLAYMENT INSTALLED PER FORTIFIED STANDARD DETAILS F-SRD-2, F-SRD-3, OR F-SRD-4. 4. SHINGLE MANUFACTURER APPROVED ASTM D1970 FULLY ADHERED STARTER STRIP WITH ASPHALTIC ADHESIVE STRIP AT EAVE. DRIP EDGE AND ASTM D41 ASPHALT PRIMER INSTALLED PER FORTIFIED STANDARD DETAIL F-DE-1 AND/OR F-DE-3.			
STARTER STRIP AND SHINGLES SHALL NOT EXTEND MORE THAN 1/4" BEYOND DRIP EDGE.		TO MEET 2020 HAIL SUPPLEMENT REQUIREMENTS, ASPHALT SHINGLES MUST HAVE AN OVERALL IBHS ROOF SHINGLE HAIL IMPACT RATING OF "GOOD" OR "EXCELLENT" OR BE POLYMER-MODIFIED WITH EITHER A UL 2218 CLASS 4 OR FM 4473 CLASS 4 RATING.	
ASTM D3161 (CLASS F) OR ASTM D7158 (CLASS H) ASPHALT SHINGLES INSTALLED PER MANUFACTURER RECOMMENDATIONS FOR HIGH WIND REGIONS.			
<b>DATE:</b> 11/01/2020			

**F-RC-2**

	<p><b>APPLICABLE STANDARDS:</b></p> <p>FORTIFIED HOME™ - HURRICANE (2020)          FORTIFIED HOME™ - HIGH WIND (2020)</p>	<p><b>DESCRIPTION:</b></p> <p>ASPHALT SHINGLE INSTALLATION GUIDANCE FOR STEEP SLOPE - OPTION 2: SHINGLE STRIP STARTER INSTALLATION AT EAVE OR RAKE</p>	<p><b>DRAWING #:</b></p> <p>F-RC-2</p>
<p><b>GENERAL NOTES:</b></p> <ol style="list-style-type: none"> <li>1. REFER TO APPLICABLE FORTIFIED HOME STANDARDS FOR ADDITIONAL INFORMATION.</li> <li>2. SHINGLES INSTALLED AT ALL INTERSECTIONS AND BOTH SIDES OF OPEN VALLEYS SHALL BE SET IN A MINIMUM 8 IN. WIDE STRIP OF FLASHING CEMENT (MAX. THICKNESS OF FLASHING CEMENT = 1/8"). CUT SIDE OF CLOSED VALLEYS SHALL BE SET IN A MINIMUM 2 IN. WIDE, 1/8" THICK STRIP OF FLASHING CEMENT. WOVEN VALLEYS TO BE ACCORDING TO THE MANUFACTURERS SPECIFICATIONS.</li> <li>3. REFER TO FORTIFIED STANDARD DETAILS F-RC-1 AND F-RC-3 FOR ADDITIONAL ASPHALT SHINGLE INSTALLATION OPTIONS. FORTIFIED HOME STANDARDS ARE TO BE APPLIED IN CONJUNCTION WITH FEDERAL, STATE, AND LOCAL CODES, ORDINANCES AND REGULATIONS IN ADDITION TO THE STRUCTURAL DESIGN WHICH IS BY OTHERS. IN CASE OF A CONFLICT BETWEEN PROVISIONS, USE WHICHEVER IS MORE STRINGENT.</li> <li>4. UNDERLAYMENT INSTALLED PER FORTIFIED STANDARD DETAILS F-SRD-2, F-SRD-3, OR F-SRD-4.</li> </ol>		<p>SHINGLE MANUFACTURER APPROVED STARTER STRIP SET IN A MINIMUM 8 IN. WIDE STRIP OF COMPATIBLE FLASHING CEMENT (MAX. THICKNESS OF FLASHING CEMENT = 1/8").</p> <p>VERIFY WITH MANUFACTURER THAT FLASHING CEMENT/ROOF MASTIC IS COMPATIBLE WITH UNDERLAYMENT.</p> <p>DRIP EDGE AND ASTM D41 ASPHALT PRIMER INSTALLED PER FORTIFIED STANDARD DETAIL F-DE-1 AND/OR F-DE-3.</p> <p>STARTER STRIP AND SHINGLES SHALL NOT EXTEND MORE THAN 1/4 IN. BEYOND DRIP EDGE.</p> <p>ASTM D3161 (CLASS F) OR ASTM D7158 (CLASS H) ASPHALT SHINGLES INSTALLED PER MANUFACTURER RECOMMENDATIONS FOR HIGH WIND REGIONS.</p> <div style="border: 1px solid black; padding: 5px; margin-top: 10px;"> <p><b>TO MEET 2020 HAIL SUPPLEMENT REQUIREMENTS, ASPHALT SHINGLES MUST HAVE AN OVERALL IBHS ROOF SHINGLE HAIL IMPACT RATING OF "GOOD" OR "EXCELLENT" OR BE POLYMER-MODIFIED WITH EITHER A UL 2218 CLASS 4 OR FM 4473 CLASS 4 RATING.</b></p> </div>	

**F-RC-3**

	<b>APPLICABLE STANDARDS:</b> FORTIFIED HOME™ - HURRICANE (2020) FORTIFIED HOME™ - HIGH WIND (2020)	<b>DESCRIPTION:</b> ASPHALT SHINGLE INSTALLATION GUIDANCE FOR STEEP SLOPE - OPTION 3: SHINGLES SET DIRECTLY IN FLASHING CEMENT AT RAKE ONLY	<b>DRAWING #:</b> F-RC-3  <b>DATE:</b> 11/01/2020
<p><b>GENERAL NOTES:</b></p> <ol style="list-style-type: none"> <li>1. REFER TO APPLICABLE FORTIFIED HOME STANDARDS FOR ADDITIONAL INFORMATION.</li> <li>2. SHINGLES INSTALLED AT ALL INTERSECTIONS AND BOTH SIDES OF OPEN VALLEYS SHALL BE SET IN A MINIMUM 8 IN. WIDE STRIP OF FLASHING CEMENT (MAX. THICKNESS OF FLASHING CEMENT = 1/8"). CUT SIDE OF CLOSED VALLEYS SHALL BE SET IN A MINIMUM 2 IN. WIDE, 1/8" THICK STRIP OF FLASHING CEMENT. WOVEN VALLEYS TO BE ACCORDING TO THE MANUFACTURER'S SPECIFICATIONS.</li> <li>3. REFER TO FORTIFIED STANDARD DETAILS F-RC-1 AND F-RC-2 FOR ADDITIONAL ASPHALT SHINGLE INSTALLATION OPTIONS. FORTIFIED HOME STANDARDS ARE TO BE APPLIED IN CONJUNCTION WITH FEDERAL, STATE, AND LOCAL CODES, ORDINANCES AND REGULATIONS IN ADDITION TO THE STRUCTURAL DESIGN WHICH IS BY OTHERS. IN CASE OF A CONFLICT BETWEEN PROVISIONS, USE WHICHEVER IS MORE STRINGENT.</li> <li>4. UNDERLAYMENT INSTALLED PER FORTIFIED STANDARD DETAILS F-SRD-2, F-SRD-3, OR F-SRD-4.</li> </ol> <p>D RIP EDGE AND ASTM D41 ASPHALT PRIMER INSTALLED PER FORTIFIED STANDARD DETAIL F-DE-1 AND/OR F-DE-3.</p> <p>SHINGLES SET DIRECTLY IN A MINIMUM 8 IN. WIDE STRIP OF COMPATIBLE FLASHING CEMENT (MAX. THICKNESS OF FLASHING CEMENT = 1/8"). VERIFY WITH MANUFACTURER THAT FLASHING CEMENT/ROOF MASTIC IS COMPATIBLE WITH UNDERLAYMENT.</p> <p><b>TO MEET 2020 HAIL SUPPLEMENT REQUIREMENTS, ASPHALT SHINGLES MUST HAVE AN OVERALL IBHS ROOF SHINGLE HAIL IMPACT RATING OF "GOOD" OR "EXCELLENT" OR BE POLYMER-MODIFIED WITH EITHER A UL 2218 CLASS 4 OR FM 4473 CLASS 4 RATING.</b></p> <p>ASTM D3161 (CLASS F) OR ASTM D7158 (CLASS H) ASPHALT SHINGLES INSTALLED PER MANUFACTURER RECOMMENDATIONS FOR HIGH WIND REGIONS. SHINGLES SHALL NOT EXTEND MORE THAN 1/4" BEYOND DRIP EDGE.</p>			

F-RR-1

	<p><b>APPLICABLE STANDARDS:</b> FORTIFIED HOME™ - HURRICANE (2020) FORTIFIED HOME™ - HIGH WIND (2020)</p>	<p><b>DESCRIPTION:</b> RE-ROOFING DECK REPLACEMENT FASTENING DETAIL</p>	<p><b>DRAWING #:</b> F-RR-1</p> <p><b>DATE:</b> 11/01/2020</p>
<p><b>GENERAL NOTES:</b></p> <ol style="list-style-type: none"> <li>REFER TO APPLICABLE FORTIFIED HOME STANDARDS FOR ADDITIONAL INFORMATION. WHEN REPLACING AN ENTIRE DAMAGED SHEET WITH A DIMENSION OF LESS THAN 24" IN ANY DIRECTION, PROVIDE 2X4 BLOCKING ALONG ALL UNSUPPORTED EDGES, AND FASTEN SHEATHING IN ACCORDANCE WITH F-RR-3 AND F-RR-4.</li> <li>FORTIFIED HOME STANDARDS ARE TO BE APPLIED IN CONJUNCTION WITH FEDERAL, STATE, AND LOCAL CODES, ORDINANCES AND REGULATIONS, IN ADDITION TO THE STRUCTURAL DESIGN WHICH IS BY OTHERS. IN CASE OF A CONFLICT BETWEEN PROVISIONS, USE WHICHEVER IS MORE STRINGENT.</li> <li>AT PANEL ENDS, PROVIDE 2 X 4 SCAB FASTENED TO EXISTING MEMBER W/ 16D NAILS @ 4" O.C. STAGGERED, TYP. OF (2).</li> </ol> <p>EXISTING ROOF SHEATHING BY OTHERS W/ 7/16" MIN. THICKNESS AND NO DAMAGE OR DETERIORATION. REFER TO FORTIFIED STANDARD DETAILS F-RR-3 AND F-RR-4 FOR RE-NAILING SCHEDULE.</p> <p>REFER TO FORTIFIED STANDARD DETAILS F-RR-3 AND F-RR-4 FOR REQUIRED NAILING, ATTACH NEW ROOF DECK TO SCAB (NOT EXISTING ROOF MEMBER), TYP.</p> <p>PREVIOUSLY DAMAGED ROOF DECK AREA. INSPECT ROOF SUPPORT MEMBERS BELOW FOR DETERIORATION OR DAMAGE AND REPLACE ENTIRE SHEET.</p> <p>NEW ROOF DECK REPLACEMENT FASTENED TO SCAB, BLOCKINGS (IF APPLICABLE) AND EXISTING FRAMING IN ACCORDANCE WITH FORTIFIED STANDARD DETAILS F-RR-3 AND F-RR-4.</p>			



**F-RR-2**

	<p><b>APPLICABLE STANDARDS:</b>          FORTIFIED HOME™ - HURRICANE (2020)          FORTIFIED HOME™ - HIGH WIND (2020)</p>	<p><b>DESCRIPTION:</b>          RE-ROOFING NEW SCAB MEMBER DETAIL FOR DAMAGED OR DETERIORATED WOOD FRAMING MEMBER</p>	<p><b>DRAWING #:</b>          F-RR-2</p> <p><b>DATE:</b>          11/01/2020</p>
<p><b>GENERAL NOTES:</b></p> <ol style="list-style-type: none"> <li>REFER TO APPLICABLE FORTIFIED HOME STANDARDS FOR ADDITIONAL INFORMATION. SCAB WOOD MEMBERS MAY BE TRIMMED UP TO A MAXIMUM OF 1/2" AT THE BOTTOM TO FACILITATE INSTALLATION.</li> <li>IF DAMAGE IS GREATER THAN THE CONDITIONS SHOWN, CONSULT A LICENSED PROFESSIONAL ENGINEER TO PROVIDE ENGINEERING DETAILS TO REPAIR THE DAMAGE. DAMAGED/DETERIORATED AREA MUST BE A MINIMUM OF 6 IN. AWAY FROM ANY MECHANICAL CONNECTIONS (I.E. TRUSS/Rafter HANGERS, TRUSS CONNECTOR PLATES, ETC.)</li> <li>WHEN THE FASCIA OR SUB-FASCIA IS THE ROOF FRAMING MEMBER THAT IS DAMAGED OR DETERIORATED, REMOVE AND REPLACE THE DAMAGED/DETERIORATED SECTION PLUS AT LEAST 2 FT. BEYOND THAT SECTION ON EACH SIDE.</li> <li>FORTIFIED HOME STANDARDS ARE TO BE APPLIED IN CONJUNCTION WITH FEDERAL, STATE, AND LOCAL CODES, ORDINANCES AND REGULATIONS IN ADDITION TO THE STRUCTURAL DESIGN WHICH IS BY OTHERS. IN CASE OF A CONFLICT BETWEEN PROVISIONS, USE WHICHEVER IS MORE STRINGENT.</li> </ol>			

**F-RR-3**

	<p><b>APPLICABLE STANDARDS:</b> FORTIFIED HOME™ - HURRICANE (2020)</p>	<p><b>DESCRIPTION:</b> HURRICANE - RE-NAILING THE ROOF DECK (WOOD STRUCTURAL PANELS)</p>	<p><b>DRAWING #:</b> F-RR-3</p> <p><b>DATE:</b> 11/01/2020</p>
<p><b>GENERAL NOTES:</b></p> <ol style="list-style-type: none"> <li>REFER TO APPLICABLE FORTIFIED HOME STANDARDS FOR ADDITIONAL INFORMATION.</li> <li>FORTIFIED HOME STANDARDS ARE TO BE APPLIED IN CONJUNCTION WITH FEDERAL, STATE, AND LOCAL CODES, ORDINANCES AND REGULATIONS, IN ADDITION TO THE STRUCTURAL DESIGN WHICH IS BY OTHERS. IN CASE OF A CONFLICT BETWEEN PROVISIONS, USE WHICHEVER IS MORE STRINGENT.</li> </ol> <p><b>KEY:</b></p> <ul style="list-style-type: none"> <li>○ = EXISTING FASTENERS</li> <li>⊕ = ADDITIONAL FASTENERS</li> <li>A = SPACING OF ADDITIONAL FASTENERS</li> <li>B = SPACING BETWEEN EXISTING AND ADDITIONAL FASTENER</li> </ul> <p><b>EXISTING FASTENERS:</b> IF IT CAN BE DOCUMENTED THAT EXISTING NAILING MEETS THE REQUIREMENTS OF F-RR-2, THEN SUPPLEMENTAL FASTENING (+) IS NOT REQUIRED.</p> <p><b>⊕ ADDITIONAL 0.113" X 2-3/8" 8D RING SHANK NAILS @ = 4" O.C.</b></p> <p><b>○ EXISTING FASTENERS:</b> IF IT CAN BE DOCUMENTED THAT EXISTING NAILING MEETS THE REQUIREMENTS OF F-RR-2, THEN SUPPLEMENTAL FASTENING (+) IS NOT REQUIRED.</p> <p><b>2'-0" MAX.</b></p> <p><b>EXISTING ROOF FRAMING MEMBERS W/ 2" MIN. NOMINAL THICKNESS. REFER TO F-RR-2 FOR GUIDANCE ON DETERIORATED OR DAMAGED MEMBERS.</b></p> <p><b>EXISTING STRUCTURAL WOOD PANEL ROOF SHEATHING (PLYWOOD OR OSB) W/ NO DAMAGE OR DETERIORATION. REFER TO F-RR-1 FOR DAMAGED OR DETERIORATED SHEATHING. REFER TO F-RR-2 FOR SHEATHING THICKNESS REQUIREMENTS.</b></p> <p><b>B : TO AVOID WOOD SPLITTING, SPACING BETWEEN NEW AND EXISTING NAILS "B" SHALL NOT BE LESS THAN 2 IN. NAILS SHALL BE STAGGERED WHEN "B" IS LESS THAN OR EQUAL TO 3 IN.</b></p> <p><b>FIGURE 1.</b></p> <p><b>Round Head (OK)</b> </p> <p><b>Off Center (OK)</b> </p> <p><b>Clipped Head (No)</b> </p>			

**F-RR-4**

	<p><b>APPLICABLE STANDARDS:</b> FORTIFIED HOME™ - HIGH WIND (2020)</p>	<p><b>DESCRIPTION:</b> HIGH WIND - RE-NAILING THE ROOF DECK (WOOD STRUCTURAL PANELS)</p>	<p><b>DRAWING #:</b> F-RR-4</p> <p><b>DATE:</b> 11/01/2020</p>
<p><b>GENERAL NOTES:</b></p> <ol style="list-style-type: none"> <li>REFER TO APPLICABLE FORTIFIED HOME STANDARDS FOR ADDITIONAL INFORMATION.</li> <li>REFER TO F-RS-3 FOR MINIMUM SHEATHING THICKNESS REQUIREMENTS.</li> <li>FORTIFIED HOME STANDARDS ARE TO BE APPLIED IN CONJUNCTION WITH FEDERAL, STATE, AND LOCAL CODES, ORDINANCES AND REGULATIONS IN ADDITION TO THE STRUCTURAL DESIGN WHICH IS BY OTHERS. IN CASE OF A CONFLICT BETWEEN PROVISIONS, USE WHICHEVER IS MORE STRINGENT.</li> </ol> <p><b>KEY:</b></p> <ul style="list-style-type: none"> <li>○ = EXISTING FASTENERS</li> <li>⊕ = ADDITIONAL FASTENERS</li> <li>A = SPACING OF ADDITIONAL FASTENERS</li> <li>B = SPACING BETWEEN EXISTING AND ADDITIONAL FASTENER</li> </ul> <p><b>EXISTING FASTENERS, IF IT CAN BE DOCUMENTED THAT EXISTING NAILING MEETS THE REQUIREMENTS OF F-RS-3, THEN SUPPLEMENTAL FASTENING (+) IS NOT REQUIRED.</b></p> <p><b>ADDITIONAL 0.13" X 2-3/8" 8D RING SHANK NAILS @ 6" O.C.</b></p> <p><b>REFER TO GENERAL NOTE #3 FOR ROOF MEMBER SPACING REQUIREMENTS</b></p> <p><b>EXISTING STRUCTURAL WOOD PANEL ROOF SHEATHING (PLYWOOD OR OSB) BY OTHERS W/ NO DAMAGE OR DETERIORATION. REFER TO F-RR-1 FOR DAMAGED OR DETERIORATED SHEATHING. REFER TO F-RS-3 FOR SHEATHING THICKNESS REQUIREMENTS.</b></p> <p><b>B : TO AVOID WOOD SPLITTING, SPACING BETWEEN NEW AND EXISTING NAILS "B" SHALL NOT BE LESS THAN 2 IN. NAILS SHALL BE STAGGERED WHEN "B" IS LESS THAN OR EQUAL TO 3 IN.</b></p> <p><b>EXISTING ROOF FRAMING MEMBERS W/ 2" MIN. NOMINAL THICKNESS. REFER TO F-RR-2 FOR GUIDANCE ON DAMAGED OR DETERIORATED MEMBERS.</b></p> <p><b>FIGURE 1.</b></p> <p>Round Head (OK)      Off Center (OK)      Clipped Head (No)</p>			

**F-RR-5**

	<p><b>APPLICABLE STANDARDS:</b>          FORTIFIED HOME™ - HURRICANE (2020)          FORTIFIED HOME™ - HIGH WIND (2020)</p>	<p><b>DESCRIPTION:</b>          FASTENING WOOD STRUCTURAL PANEL ROOF SHEATHING OVER EXISTING 1X ROOF DECK BOARDS WITH GAPS</p>	<p><b>DRAWING #:</b>          F-RR-5</p> <p><b>DATE:</b>          11/01/2020</p>
<div style="display: flex; justify-content: space-between;"> <div style="width: 45%;"> <p><b>GENERAL NOTES:</b></p> <ol style="list-style-type: none"> <li>REFER TO APPLICABLE FORTIFIED HOME STANDARDS FOR ADDITIONAL INFORMATION.</li> <li>APPLICABLE FOR ROOF PITCH 2:12 OR GREATER.</li> <li>LOCAL BUILDING CODE REQUIREMENTS FOR ROOF SHEATHING THICKNESS AND/OR NAIL SIZE/ATTACHMENT SPACING MAY BE MORE STRINGENT BASED ON SITE CONDITIONS.</li> <li>FOR CONCRETE AND CLAY TILE ROOF COVERS, MINIMUM REQUIRED SHEATHING THICKNESS IS 15/32" FULL ROUND HEAD DIAMETER; NO CLIPPED-HEAD NAILS. COMMON NAILS OR STAPLES SHALL BE ALLOWED. REFER TO FIGURE 1.</li> <li>FORTIFIED HOME STANDARDS ARE TO BE APPLIED IN CONJUNCTION WITH FEDERAL, STATE, AND LOCAL CODES, ORDINANCES AND REGULATIONS IN ADDITION TO THE STRUCTURAL DESIGN WHICH IS BY OTHERS. IN CASE OF A CONFLICT BETWEEN PROVISIONS, USE WHICHEVER IS MORE STRINGENT.</li> </ol> </div> <div style="width: 45%;"> </div> </div> <div style="margin-top: 20px;"> <p><b>FIGURE 1.</b></p> <p>Round Head (OK)          Off Center (OK)          Clipped Head (No)</p> </div>			

**F-GS-1**

- GENERAL NOTES:**
- REFER TO APPLICABLE FORTIFIED HOME STANDARDS FOR ADDITIONAL INFORMATION.
  - REFER TO FORTIFIED STANDARD DETAIL F-G-1 FOR CORROSION PROTECTION REQUIREMENTS.
  - TO MAINTAIN PROPER ATTIC VENTILATION, VENT SHUTTERING MAY BE PERFORMED ON A TEMPORARY BASIS ONLY AND SHUTTERS ARE TO BE REMOVED AFTER A STORM THREAT IS OVER. ADEQUATE ATTIC VENTILATION MUST BE MAINTAINED ON A REGULAR BASIS.**
  - FORTIFIED HOME STANDARDS ARE TO BE APPLIED IN CONJUNCTION WITH FEDERAL, STATE, AND LOCAL CODES, ORDINANCES AND REGULATIONS IN ADDITION TO THE STRUCTURAL DESIGN WHICH IS BY OTHERS. IN CASE OF A CONFLICT BETWEEN PROVISIONS, USE WHICHEVER IS MORE STRINGENT.

WOOD STRUCTURAL PANEL OR OTHER NONPOROUS FLAT SHUTTER CUT TO FIT W/ 7/16" MIN. THICKNESS. PRE-DRILL HOLES AT FASTENER LOCATIONS. SHAPE MAY VARY, BUT NOT TO EXCEED MAX. DIMENSIONS AND FASTENER SPACING SHOWN.

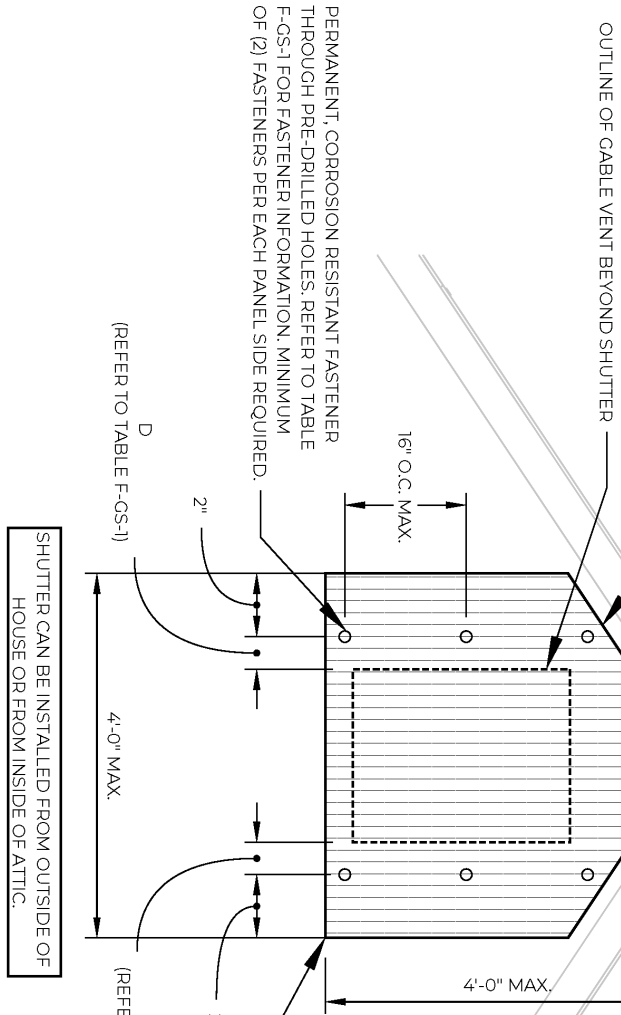

**TABLE F-GS-1: FASTENING SCHEDULE FOR CABLE VENT COVER.**

SUPPORT STRUCTURE TYPE	FASTENER TYPE & SIZE	END DISTANCE, D
WOOD	1/4" Ø LAG SCREWS W/ 2" EMBEDMENT & 1" Ø WASHER	1"
CONCRETE OR GROUTED MASONRY	1/4" Ø FASTENER W/ 2" EMBEDMENT & 1" Ø WASHER	1.5"

NOTES: WHERE SCREWS ARE ATTACHED TO MASONRY OR MASONRY/STUCCO, USE VIBRATION-RESISTANT ANCHORS W/ 1500 LBS. MIN. WITHDRAWAL CAPACITY.

NOTE: SELF-ADHESIVE WEATHER STRIPPING CAN BE USED TO SEAL THE SHUTTERS TO THE TRIM BOARDS AROUND INSIDE OF ATTIC. ENSURE THAT ANY WATER THAT ACCUMULATES IN THE CAVITY CAN DRAIN TO THE OUTSIDE OF THE HOUSE AND NOT INTO THE WALL BELOW.

	<p><b>APPLICABLE STANDARDS:</b></p> <p>FORTIFIED HOME™ - HURRICANE (2020)</p>	<p><b>DESCRIPTION:</b></p> <p>TEMPORARY CABLE VENT SHUTTERING</p>	<p><b>DRAWING #:</b></p> <p>F-GS-1</p>
	<p><b>DATE:</b></p> <p>11/01/2020</p>		

**F-GE-1**

**GENERAL NOTES:**  
 REFER TO APPLICABLE FORTIFIED HOME STANDARDS FOR ADDITIONAL INFORMATION.  
 SOFFIT PANELS IN CABLE END OVERHANGS CANNOT BE VENTED. FORTIFIED HOME STANDARDS ARE TO BE APPLIED IN CONJUNCTION WITH FEDERAL, STATE, AND LOCAL CODES, ORDINANCES AND REGULATIONS IN ADDITION TO THE STRUCTURAL DESIGN WHICH IS BY OTHERS. IN CASE OF A CONFLICT BETWEEN PROVISIONS, USE WHICHEVER IS MORE STRINGENT.

**TABLE F-GE-1: RAKE OVERHANG OUTLOOKER MAXIMUM LENGTH AND CONNECTION REQUIREMENTS.**

Ultimate Wind Speed, $V_{ult}$ (mph)	Exposure B&C		Exposure D	
	Max. Overhang Length (in) <sup>1</sup>	Uplift Connection at Gable End <sup>1,3,4,5</sup>	Max. Overhang Length (in) <sup>1</sup>	Uplift Connection at Gable End <sup>1,3,4,5</sup>
130	24	Simpson H10A USP RT16A	22	Simpson H10A USP RT16A
140	22	Simpson H10A USP RT16A	18	Simpson H10A USP RT16A
150	20	Simpson H10A USP RT16A	16	Simpson H10A USP RT16A
160	16	Simpson H10A USP RT16A	14	Simpson H10A USP RT16A
170	14	Simpson H10A USP RT16A	14	Simpson H14
180	14	Simpson H14	14	Simpson H14

**1.** Both outlooker framing spacing and connector spacing are @ 24" O.C. max.

**2.** Loads are per the 2018 Wood Frame Construction Manual and ASCE 7-16.

**3.** Simpson H10A connection requires (9) 0.148 x 1-1/2 nails to outlooker and (9) 0.148 x 1-1/2 nails to gable end top chord.

**4.** USP RT16A connection requires (9) 0.148 x 1-1/2 nails to outlooker and (8) 0.148 x 1-1/2 nails to gable end top chord.

**5.** Simpson H14 connection requires (12) 0.131 x 1-1/2 nails to outlooker and (15) 0.131 x 2-1/2 nail to gable end top chord.

**24" OVERHANG MAX.**

**NO LESS THAN OVERHANG**

**24" O.C., TYP.**

**ROOF FRAMING MEMBERS @ MAX**

**REFER TO FORTIFIED HOME HURRICANE STANDARD FOR SOFFIT REQUIREMENTS.**

**GABLE END TRUSS (FRAMED GABLE END WALL SIMILAR)**

**SIMPSON LUD4 OR USP J124 JOIST FACE HANGER W/ (4) 0.162 X 3-1/2" NAILS TO TRUSS AND (2) 0.148 X 1-1/2" NAILS TO OUTLOOKER.**

**SADDLE-TYPE HURRICANE CLIP AT CABLE END, REFER TO TABLE F-GE-1 FOR MINIMUM UPLIFT CONNECTION REQUIREMENTS.**

**TOP OF CABLE MUST BE DROPPED WIDTH OF OUTLOOKER**

**2" X4" CONTINUOUS OUTLOOKER MIN. @ MAX 24" O.C., TYP. OUTLOOKER MUST BE POSITIONED IN EDGEWISE ORIENTATION. (FLATWISE IS NOT ACCEPTABLE).**

**TYPICAL JOIST HANGER PERSPECTIVE VIEW**

**TYPICAL SADDLE-TYPE CLIP PERSPECTIVE VIEW**

**APPLICABLE STANDARDS:**  
 FORTIFIED HOME™ - HURRICANE (2020)

**DESCRIPTION:**  
 PRESCRIPTIVE CABLE END OUTLOOKER FRAMING AND ANCHORAGE

**DRAWING #:**  
 F-GE-1

**DATE:**  
 11/01/20

**F-S-1**

**GENERAL NOTES:**

- REFER TO APPLICABLE FORTIFIED HOME STANDARDS FOR ADDITIONAL INFORMATION. FORTIFIED HOME STANDARDS ARE TO BE APPLIED IN CONJUNCTION WITH FEDERAL, STATE, AND LOCAL CODES, ORDINANCES AND REGULATIONS, IN ADDITION TO THE STRUCTURAL DESIGN WHICH IS BY OTHERS, IN CASE OF A CONFLICT BETWEEN PROVISIONS, USE WHICHEVER IS MORE STRINGENT.
-

**EXISTING ROOF SUPPORTING MEMBER (TRUSS OR RAFTER) @ 24" O.C. FASTENED TO SUPPORTING WALL, VERIFY.**

**FOR 12" OR LESS BRACE NOT NEEDED**

**2" X 2" MIN. WOOD SUPPORT MEMBER (HORIZONTAL OR VERTICAL) AT EACH ROOF MEMBER LOCATION (24" O.C. MAX) W/ (2) #8 X 3" SCREWS @ EA. END, TYP.**

**2" X 2" MIN. CONTINUOUS WOOD SUPPORT FASTENED TO WALL WITH 1/4" DIAMETER SCREW X 1.25" EMBED INTO WALL @ EACH WOOD STUD LOCATION, OR @ MAX. 16" O.C., TYP.**

**SOFFIT PANEL FASTENED TO ALL WOOD SUPPORTS AT EACH PANEL LAP (INTERLOCK), SPACING NOT TO EXCEED 12" O.C. REFER TO APPENDIX B TABLE B2.2 FOR ASD WIND DESIGN PRESSURES FOR SOFFIT PANELS.**

**2" X 2" MIN. CONTINUOUS WOOD MEMBER SPACED @ MAX. 12" O.C. FASTENED TO WOOD SUPPORT W/ #8X3" SCREW AT EACH INTERSECTION, TYP.**

**SUPPORTS CAN BE VERTICAL OR HORIZONTAL**

**FASTENERS FOR SOFFIT PANEL MUST BE CORROSION RESISTANT AND MINIMUM ONE OF THE FOLLOWING:**

STAPLE 7/16" CROWN X 7/8" LENGTH X 16 GA.
NAIL 6D X 1" EMBEDMENT
SCREW #8 X 1" EMBEDMENT

**APPLICABLE STANDARDS:**

FORTIFIED HOME™ - HURRICANE (2020)

**DESCRIPTION:**

SOFFIT RETROFIT DETAIL

**DRAWING #:**

F-S-1

**DATE:**

11/01/2020



**F-CTD-1**

	<p><b>APPLICABLE STANDARDS:</b></p> <p>FORTIFIED HOME™ - HURRICANE (2020)          FORTIFIED HOME™ - HIGH WIND (2020)</p>	<p><b>DESCRIPTION:</b></p> <p>PRESCRIPTIVE CHIMNEY TIE-DOWN          DETAIL FOR CHIMNEYS UP TO 5 FT</p>	<p><b>DRAWING #:</b></p> <p>F-CTD-1</p> <p><b>DATE:</b></p> <p>11/01/20</p>
<div style="display: flex; justify-content: space-between;"> <div style="width: 45%;"> <p>GENERAL NOTES:</p> <ol style="list-style-type: none"> <li>REFER TO APPLICABLE FORTIFIED HOME STANDARDS FOR ADDITIONAL INFORMATION.</li> <li>PRESCRIPTIVE RETROFIT GUIDANCE IS APPLICABLE FOR CHIMNEYS LOCATED IN THE INTERIOR ZONE OF THE ROOF (ZONE 1) AND EXTENDING LESS THAN 5 FT ABOVE THE ROOF DECK. ANCHORAGE FOR CHIMNEYS OUTSIDE OF THESE LIMITATIONS REQUIRES ENGINEERING REVIEW AND DETAILING BY A PROFESSIONAL ENGINEER.</li> <li>FORTIFIED HOME STANDARDS ARE TO BE APPLIED IN CONJUNCTION WITH FEDERAL, STATE, AND LOCAL CODES, ORDINANCES AND REGULATIONS IN ADDITION TO THE STRUCTURAL DESIGN WHICH IS BY OTHERS. IN CASE OF A CONFLICT BETWEEN PROVISIONS, USE WHICHEVER IS MORE STRINGENT.</li> </ol> </div> <div style="width: 50%;"> </div> </div>			

## Appendix B. Design Information

### Appendix B1. Roof Sheathing Attachment Requirements Outside of FORTIFIED Prescriptive Parameters

FORTIFIED prescriptive roof sheathing attachment requirements are applicable within the parameters described in [section 2.5](#). For conditions outside of these parameters, roof sheathing attachments may be independently verified by a professional engineer (refer to [Appendix D](#) for definition) as described in [section 2.5](#) and roof sheathing attachments must provide a safety factor of 2.0 against ASD roof design wind uplift pressures specified by ASCE 7 (or LRFD-based wind uplift design pressures shall be increased by 25%).

### Appendix B2. FORTIFIED Minimum Pressure Requirement Tables

**Table B2.1.** Low Slope Roof ASD Wind Uplift Design Pressures (psf) for Roof Heights 30 ft or less

Low-Slope Roof ASD Wind Uplift Design Pressures (psf) for Roof Heights 30 ft or less			
Ultimate Wind Speed, $V_{ult}$ (mph)	ASCE Edition	Exposure B&C	Exposure D
130	7-10	64	76
	7-16	73	87
140	7-10	75	88
	7-16	85	100
150	7-10	86	102
	7-16	97	115
160	7-10	98	116
	7-16	111	131
170	7-10	110	130
	7-16	125	148
180	7-10	124	146
	7-16	140	166

#### **Notes**

- Design pressures provided are intended to be preliminary guidance for use with the FORTIFIED Home program and correspond to worst case corner zone locations for flat roofs per ASCE 7. Design pressures must meet or exceed local code requirements.

**Table B2.2.** ASD Wind Design Pressures (psf) for Soffit Panels

Exposure B&C													
Soffit Height (ft)	ASCE Edition	Ultimate Wind Speed, $V_{ult}$ (mph)											
		130 mph		140 mph		150 mph		160 mph		170 mph		180 mph	
15	7-10	22	-29	26	-34	29	-39	34	-45	38	-50	42	-57
	7-16	22	-30	26	-34	29	-34	34	-45	38	-51	42	-57
20	7-10	23	-31	27	-36	31	-41	36	-48	40	-53	45	-60
	7-16	24	-32	27	-37	31	-37	36	-48	40	-54	45	-60
25	7-10	25	-32	29	-38	33	-43	37	-50	42	-55	47	-63
	7-16	24	-32	28	-37	32	-37	36	-48	41	-54	46	-61
30	7-10	25	-34	30	-39	34	-45	39	-52	44	-57	49	-66
	7-16	26	-34	30	-40	34	-40	39	-52	44	-59	49	-66
35	7-10	26	-35	31	-41	35	-46	40	-54	45	-59	51	-68
	7-16	26	-35	31	-41	35	-41	40	-54	45	-61	51	-68
Exposure D													
Soffit Height (ft)	ASCE Edition	Ultimate Wind Speed, $V_{ult}$ (mph)											
		130 mph		140 mph		150 mph		160 mph		170 mph		180 mph	
15	7-10	27	-35	31	-41	36	-47	41	-54	46	-60	51	-69
	7-16	27	-36	31	-42	36	-42	41	-54	46	-61	51	-69
20	7-10	28	-37	33	-43	38	-50	43	-57	48	-64	54	-73
	7-16	28	-38	33	-44	38	-44	43	-57	48	-65	54	-73
25	7-10	29	-39	34	-45	39	-52	45	-60	50	-66	56	-75
	7-16	29	-39	34	-45	39	-45	44	-59	50	-67	56	-75
30	7-10	30	-40	35	-46	40	-53	46	-61	52	-68	58	-78
	7-16	30	-41	35	-47	40	-47	46	-61	52	-69	58	-78
35	7-10	31	-41	36	-48	41	-54	47	-63	53	-70	60	-80
	7-16	31	-42	36	-48	41	-48	47	-63	53	-71	60	-80

**Notes**

1. Design pressures provided are intended to be preliminary guidance for use with the FORTIFIED Home program per ASCE 7. Design pressures must meet or exceed local code requirements.

**Table B2.3. ASD Wind Design Pressures (psf) for Components; (Windows, Entry Doors, Patio Doors, Garage Doors and Opening Protection Products for Roof Heights 30 ft or less)**

Area of Opening (ft <sup>2</sup> ) (height x width)		ASCE Edition	Exposure B&C																							
			Ultimate Wind Speed, V <sub>ult</sub> (mph)																							
			130		140		150		160		170		180													
		Zone 4		Zone 5		Zone 4		Zone 5		Zone 4		Zone 5		Zone 4		Zone 5										
10	7-10	25	-27	25	-34	30	-31	30	-39	34	-36	34	-45	39	-42	39	-52	44	-46	44	-57	49	-53	49	-66	
		26	-28	26	-34	30	-32	30	-40	34	-32	34	-40	39	-42	39	-52	44	-47	44	-59	49	-53	49	-66	
	7-16	24	-27	24	-31	28	-31	28	-36	32	-35	32	-42	37	-39	37	-48	42	-45	42	-55	47	-51	47	-61	
		24	-27	24	-32	28	-31	28	-37	33	-31	33	-37	37	-40	37	-48	42	-45	42	-55	47	-51	47	-61	
	50 (Single Car Garage)	7-10	23	-24	23	-28	27	-28	27	-32	30	-32	30	-38	35	-38	35	-43	39	-42	39	-49	44	-48	44	-55
		7-16	23	-25	23	-29	27	-29	27	-33	30	-29	30	-33	35	-38	35	-44	39	-43	39	-49	44	-48	44	-55
100 (Two Car Garage)	7-10	22	-24	22	-27	25	-27	25	-31	29	-31	29	-35	33	-35	33	-39	37	-41	37	-45	42	-46	42	-51	
	7-16	22	-24	22	-27	25	-28	25	-31	29	-28	29	-31	33	-36	33	-40	37	-41	37	-45	42	-46	42	-51	
			<b>Exposure D</b>																							
		Ultimate Wind Speed, V <sub>ult</sub> (mph)																								
		130				140				150				160				170				180				
		Zone 4		Zone 5		Zone 4		Zone 5		Zone 4		Zone 5		Zone 4		Zone 5		Zone 4		Zone 5		Zone 4		Zone 5		
10	7-10	30	-32	30	-40	35	-37	35	-46	40	-43	40	-53	46	-50	46	-61	52	-55	52	-68	58	-63	58	-78	
		30	-33	30	-41	35	-38	35	-47	40	-38	40	-47	46	-50	46	-62	52	-56	52	-69	58	-63	58	-78	
20	7-10	29	-32	29	-37	34	-37	34	-43	39	-42	39	-50	44	-46	44	-56	49	-53	49	-65	55	-60	55	-73	
		29	-32	29	-38	34	-37	34	-44	39	-37	39	-44	44	-48	44	-57	49	-54	49	-65	56	-60	56	-73	
50 (Single Car Garage)	7-10	27	-28	27	-33	32	-33	32	-38	36	-38	36	-45	41	-45	41	-51	46	-50	46	-58	52	-57	52	-66	
	7-16	27	-30	27	-34	32	-35	32	-40	36	-35	36	-40	41	-45	41	-52	46	-51	46	-59	52	-57	52	-66	
100 (Two Car Garage)	7-10	26	-28	26	-32	30	-32	30	-37	34	-37	34	-42	39	-42	39	-46	44	-48	44	-53	49	-54	49	-60	
	7-16	26	-28	26	-32	30	-33	30	-37	34	-33	34	-37	39	-43	39	-48	44	-48	44	-54	49	-54	49	-60	

**Notes**  
 1. Design pressures provided are intended to be preliminary guidance for use with the FORTIFIED Home program per ASCE 7. Refer to FORTIFIED Standard Detail F-G-2 for identification of Zones 4 and 5. Design pressures must meet or exceed local code requirements.

## Appendix C. References

- American Iron and Steel Institute (AISI)
  - [steel.org](http://steel.org)
  - [American Iron and Steel Institute \(AISI\) North American Standard for Cold-Formed Steel Framing – Prescriptive Method for One and Two Family Dwellings \(AISI S230\)](#)
- American Society of Civil Engineers (ASCE)
  - [asce.org](http://asce.org)
  - American Society of Civil Engineers Minimum Design Loads for Building and Other Structures (ASCE 7)
- American Wood Council (AWC)
  - [awc.org](http://awc.org)
  - [Wood Frame Construction Manual \(WFCM\) 2015 Edition](#)
  - [Wood Frame Construction Manual \(WFCM\) 2018 Edition](#)
- Asphalt Roofing Manufacturers Association (ARMA)
  - [www.asphaltroofing.org](http://www.asphaltroofing.org)
  - [Residential Asphalt Roofing Manual Design and Application Methods](#)
- ASTM International Designation F1667; Standard Specification for Driven Fasteners: Nails, Spikes, and Staples
- Cedar Shake and Shingle Bureau (CSSB)
  - [www.cedarbureau.org](http://www.cedarbureau.org)
  - [Cedar Shake and Shingle Bureau \(CSSB\) New Roof Construction Manual, March 2017 Edition](#)
- The Florida Building Code (FBC)
  - [www.floridabuilding.org](http://www.floridabuilding.org)
  - [2017 Florida Building Code – Test Protocols for High Velocity-Hurricane Zone, Sixth Edition](#)
  - [2014 Florida Building Code – Test Protocols for High-Velocity Hurricane Zones](#)
- Florida Roofing and Sheet Metal Contractors Association (FRSA)
  - [www.floridarroof.com](http://www.floridarroof.com)
- National Roofing Contractors Association (NRCA)
  - [www.nrca.net](http://www.nrca.net)
  - [The NRCA Roofing Manual: Architectural Metal Flashing and Condensation and Air Leakage Control](#)
- Tile Roofing Institute (TRI)
  - [tileroofing.org](http://tileroofing.org)
  - [FRSA/TRI Florida High Wind Concrete and Clay Tile Installation Manual, Revised 5<sup>th</sup> Edition, 2014](#)
  - [FRSA/TRI Florida High Wind Concrete and Clay Tile Installation Manual, 6<sup>th</sup> Edition](#)

## Appendix D. Definitions

**Acceptable roof cover:** a roof that is not visibly damaged or deteriorated and has at least 5 years of useful life remaining is eligible for acceptance as part of a FORTIFIED Roof – Existing Roof designation. A certified FORTIFIED Evaluator must inspect the roof to determine the condition and remaining useful life of the roof covering. Roof coverings that are damaged or deteriorated, or with less than 5 years remaining useful life as determined by the IBHS-certified evaluator are not eligible for a FORTIFIED Roof – Existing Roof designation. However, if the home is re-roofed in accordance with FORTIFIED Roof – New Roof designation requirements specified in Section 2.2.3, it is eligible for a FORTIFIED Roof – New Roof designation when all additional FORTIFIED Roof requirements are met.

**Bearing point:** the top of a wall that provides vertical support for the roof structure.

**Carport:** an attached carport is a structure whose roof is attached to the building or the roof structure of the dwelling and at least one side of the structure is open. A built-in carport has the roof of the house extending over the area used for parking cars, boats, or other storage.

**Certified FORTIFIED Evaluator:** an individual who has met the professional requirements for certification by IBHS, has completed the FORTIFIED training course, and has achieved a passing score on the designation certification exam.

**Components and Cladding (C&C):** Elements of the building envelope or elements of building appurtenances and rooftop structures and equipment that do not qualify as part of the main wind force resisting system (MWFRS).

**Continuous load path:** an engineering term that refers to a series of connections that allow forces, such as those created by high-wind events, to pass from one part of a structure to another and ultimately to the foundation. A continuous load path allows the building to resist the forces created by high winds as a unit. Without a continuous load path, there are “weak links” in a building’s connections. These weak links are where failures are most likely to occur.

**Damaged or deteriorated lumber:** generally, this is lumber that is marked by one or more of the following characteristics: soft or spongy, swelling or buckling, delaminating (plywood), or crumbling and flaking of the wood.

**Design pressure rating:** the allowable wind pressure rating assigned to a window, door, or opening protection product, expressed as both a positive and negative pressure. The design pressure rating is based on specific testing and a required factor of safety.

**Design wind speed:** the wind speed specified in the building code for a given location that is used in accordance with code-accepted procedures to establish wind pressures and associated forces that a building or parts of a building must be capable of resisting. Refer to [section 2.10](#) for additional information on ultimate vs. nominal wind speed.

**Designation:** A FORTIFIED Home “designation” means that a home meets all the requirements of a level of the FORTIFIED Home Program, required documentation of materials and installation has been



submitted by an authorized third party, reviewed by IBHS and a certificate of compliance for the property has been issued by IBHS.

**Documentation:** evidence that a specific requirement has been met, either in the form of a test report, manufacturer's installation guidelines, product markings, or other evidence that proves that a specific requirement has been met.

**Drip edge:** metal flashing installed at eaves and along gable rake edges.

**Exposure B:** generally refers to site locations where terrain including urban and suburban areas, wooded areas, or other terrain with numerous, closely spaced obstructions that have the size of a single-family dwelling or larger prevails in the upwind direction for greater than 1,500 ft (or 2,600 ft for homes with MRH greater than 30 ft). Refer to ASCE 7 for additional information.

**Exposure C:** generally refers to site locations where Exposure B or Exposure D do not apply (i.e. open terrain with scattered obstructions that have heights generally less than 30 ft, including flat, open country and grasslands. Refer to ASCE 7 for additional information.

**Exposure D:** generally refers to site locations where terrain including flat, unobstructed areas and water surfaces, including smooth mud flats, salt flats, and unbroken ice either prevails in the upwind direction for a distance of greater than 5,000 ft or is within 600 ft of such terrain conditions. Refer to ASCE 7 for additional information.

**Flashing:** components used to weatherproof or seal roof system edges at perimeters, penetrations, walls, expansion joints, valleys, drains, and other places where the roof covering is interrupted or terminated.

**Gable end:** the vertical triangular wall between the sloping ends of a gable roof and the rectangular wall below.

**Gable rake edge:** the edge of the roof overhang at a gable end.

**Glazed openings:** any opening in a door or wall that contains glass.

**Impact-rated products:** impact-rated products include permanently installed products like doors, windows, sliding glass doors, and skylights that have been tested and approved in accordance with, at a minimum, International Residential Code (IRC) accepted impact resistance and design pressure test standards.

**IRC:** the International Residential Code developed by the International Code Council (ICC).

**Professional engineer:** licensed professional engineer registered in the state where the home is located, with license in good standing with professional engineering board(s). Engineer shall have adequate current knowledge and practical experience in area of practice to sign and seal residential structural engineering designs.

**Living area:** conditioned space in a home that is protected from the elements by walls, windows, doors, and the roof structure.

**Low slope:** roof surfaces with a slope less than 2:12.

**Mean roof height (MRH):** the average height of the roof, usually calculated as the average of the eave and ridge height of the roof.

**Metal roof:** a roof that uses metal panels installed over and attached to a wood deck as its primary roof covering material.

**Main Wind Force Resisting System (MWFRS):** an assemblage of structural elements assigned to provide support and stability for the overall building or other structure. The system generally receives wind loading from more than one surface.

**Opening protection products:** opening protection products must be tested and approved with, at a minimum, International Residential Code (IRC) accepted test standards for the large missile (missile D: 9-lb 2x4 impacting at 50 ft/sec) impact resistance and minimum design pressure for the site, building size, opening size, and location on the building. Opening protection products include permanently or temporarily installed shutter systems like roll shutters, accordion shutters, colonial shutters, Bahama-style shutters, storm panels, and fabric and screen products.

**Outlooker:** these are usually 2x framing members that extend out over the top of the gable wall to support the sheathing on the overhang. They are typically required when the gable overhang is greater than 12 in.

**Out-of-plane wind loads:** when associated with gable ends or exterior walls, out-of-plane wind loads are wind loads that are perpendicular to the face of the gable end or exterior wall.

**Porch:** a porch is an outdoor or semi-outdoor space with a solid roof directly above it where the roof is attached to an exterior wall or part of the roof of the primary structure. It may have one or more sides that are or once were open or screened. Screen pool enclosures are not considered porches for the purpose of this program.

**Prescriptive retrofit measure:** a detailed retrofit measure provided in this guide, which does not require analysis by an engineer. These measures can be used to strengthen a home to the extent necessary to meet the requirements provided in this standard.

**Qualified roof:** a roof covering meeting high-wind-resistance criteria appropriate for the design wind speed at the location and installed according to the appropriate manufacturers installation requirements for the design wind speed and application.

**Qualified Sealed Roof Deck (SRD):** protective measures taken in addition to or as part of the underlayment system installed under the primary roof cover (i.e., shingles, tile, or metal roofing) that is designed to stay in place and keep water from entering the home if the primary roof covering is damaged or lost due to high winds.

Protective measures and underlayments that may qualify as a sealed roof deck under FORTIFIED include:

- A self-adhered membrane applied over the entire roof deck.
- A 4-in.-wide self-adhered membrane tape applied over all joints in the roof deck, covered by a roofing felt or synthetic underlayment approved as a substitute for the required roofing felt.
- Two (2) layers of approved felt installed as required in this standard, when the roof cover is asphalt shingles or metal.
- A closed-cell foam applied to all joints in the roof deck from the attic.

**Roofing component:** a roofing product that is incorporated into various roofing assemblies.

**Roof ridge:** the intersection of two roof planes at the peak of the roof.

**Roof span:** the maximum distance perpendicular to the ridge between outside bearing walls providing vertical support for the roof structure. For relatively simple buildings, this is usually the maximum distance (perpendicular to the ridge) between the outer walls that run parallel to the roof ridge.

**Shear walls:** a wall composed of braced panels (also known as shear panels) to counter the effects of lateral load acting on a structure. Wind and earthquake loads are the most common loads that shear walls are designed to resist.

**Shingle roof:** a roof that uses either asphalt or wood shingles installed over a wood deck as its primary roof covering material.

**Steep slope:** roof surfaces with a slope of 2:12 and greater.

**Tile roof:** a roof that uses either concrete or clay tile installed over a wood deck as its primary roof covering material.

**Underlayment:** a material applied to the surface of the roof deck or roof sheathing prior to the installation of the primary roof covering material.

**Wall openings:** windows and all doors, including entry doors, sliding glass doors, and garage doors.

**Wind loads:** pressures exerted on a building due to wind multiplied by the area upon which the pressures act. Wind loads are determined by applicable wind load provisions of ASCE 7 “Minimum Design Loads for Buildings and Other Structures.”

## Appendix E. IBHS Roof Shingle Hail Impact Ratings

The IBHS Roof Shingle Hail Impact ratings shown were last updated on June 25, 2020. However, the ratings change as additional testing is performed. For the most current ratings, refer to [ibhs.org](https://ibhs.org)

<https://ibhs.org/hail/shingle-performance-ratings/>

ROOF SHINGLE HAIL IMPACT RATINGS				
Manufacturer/ Brand	Overall Rating	Dents/ Ridges	Tears	Granule Loss
StormMaster® Shake	Excellent	Good	Excellent	Excellent
TruDefinition® Duration FLEX™	Good	Good	Excellent	Excellent
Roofing NorthGate®	Excellent	Marginal	Excellent	Excellent
Roofing Products Legacy®	Excellent	Good	Good	Excellent
Roofing Products Vista®	Excellent	Good	Good	Excellent
Nordic™	Excellent	Marginal	Good	Excellent
Timberline® Armorshield™ II	Excellent	Marginal	Good	Good
BUILDING PRODUCTS Heritage® IR	Marginal	Poor	Good	Good
TruDefinition® WeatherGuard® HP	Marginal	Poor	Good	Good
Roofing Landmark® IR	Marginal	Poor	Marginal	Marginal

Key  Excellent  Good  Marginal  Poor

## Appendix F. FORTIFIED Prescriptive CLP Design Limitations and Minimum Requirements for High Wind

FORTIFIED Prescriptive CLP Design Limitations and Minimum Requirements for High Wind Using the 2018 Wood Frame Construction Manual

Prescriptive CLP design measures per the 2018 Wood Frame Construction Manual may ONLY be used for homes conforming to both the limitations listed in the Wood Frame Construction Manual and the following additional FORTIFIED limitations:

- **One or two-story wood framed structure**
- **Mean roof height shall not exceed 33 ft**
- **Minimum 4/12 roof pitch**
- **Maximum building width shall not exceed 36 ft**
- **Maximum building length shall not exceed 80 ft**
- **Length of building shall not exceed 2.25 times the building width**
- **Exterior and/or shear wall line offset shall not exceed 4 ft**
- **Gables shall not exceed 10 ft height at peak**
- **Wall top plate to roof ridge height shall not exceed 10 ft**
- **Wall height shall not exceed 10 ft**
- **Wall openings shall be less than 6 ft, 0 in. wide.**
- **At any side of the structure, the total length of full-height wall (i.e., sum of lengths of wall with no openings) shall not be less than 60% of the overall wall length**
- **Structure must be supported by slab on grade reinforced concrete footing in conformance with Table F4**

A design professional may follow the prescriptive design guidance per the 2018 Wood Frame Construction Manual, incorporating fastening guidance per 2018 IRC Table R602.3(1), and the following additional minimum requirements to provide a FORTIFIED Home™–High Wind Continuous Load Path (CLP).

### 1. Design Parameters

1. Designs shall correspond to Exposure C or greater
2. Designs shall correspond to ultimate windspeed,  $V_{ult} = 130$  mph or greater
3. Roof snow load shall not exceed 30 psf
4. Roof dead load shall not exceed 20 psf

## 2. Roof Framing

Roof framing system with roof sheathing and sheathing attachment constructed to meet or exceed the following minimum requirements:

1. Minimum  $1\frac{5}{32}$ -in.-thick wood structural panels
2. Sheathing attached in accordance with one of the following fastening schedules:
3. 8d common nails or 10d box nails at 4 in. O.C. on all roof framing members
4. 8d ring-shank nails at 6 in. O.C. on all roof framing members

### 3. Roof structure

1. Roof structural members shall not exceed 24 in. O.C. spacing
2. If trusses:
  1. Engineered trusses designed for minimum  $V_{ult} = 130$  mph for terrain Exposure C
3. If rafter system:
  1. Collar ties on all rafter pairs
  2. Rafters sized for span per 2018 WFCM for minimum  $V_{ult} = 130$  mph for terrain Exposure C
  3. Install strap, with the minimum capacity listed in Table F1, over top of ridge board connecting tops of rafter pairs

**Table F1.** Required Minimum Capacities for Ridge Straps Connecting Pairs of Rafters Based on Roof Span and 24-in. Spacing between Rafters

Roof Span (ft)	20	24	28	32	36
Strap Capacity (lb)	592	710	830	948	1,066

4. Gable rake roof sheathing overhang shall not exceed 12 in. and outlooker framing member spacing shall not exceed 24 in.
5. Gables shall not exceed 10 ft height at peak and stud spacing shall not exceed 16 in. O.C.

## 3. Roof-to-Wall Connections

Anchor roof structure to exterior wall below using metal connectors following the requirements listed below:

1. Metal connectors connecting roof structure to exterior wall system at all wall-to-roof framing connections (trusses and rafters) sized to meet the load requirements of Table F2 as shown in Figure 1.

**Table F2.** Roof-to-Wall Connector Minimum Capacities Based on Roof Span and 24-in. Spacing between Rafters or Trusses

Roof Span (ft)	20	24	28	32	36
Strap Uplift Capacity (lb)	448	512	578	642	706
Strap Lateral Capacity, $F_2^3$ (lb)	308				
Strap Shear Capacity, $F_1^4$ (lb)	162R <sup>2</sup>				

**Notes:**

1. Based on 15 psf roof and ceiling dead load.
2.  $R = L/W$  for wind perpendicular to the ridge and  $R=W/L$  for wind parallel to the ridge, where  $W$  is the building width and  $L$  is the building length.
3.  $F_2$  load direction is perpendicular to the wall (Refer to Figure 1).
4.  $F_1$  load direction is parallel to the wall (Refer to Figure 1).

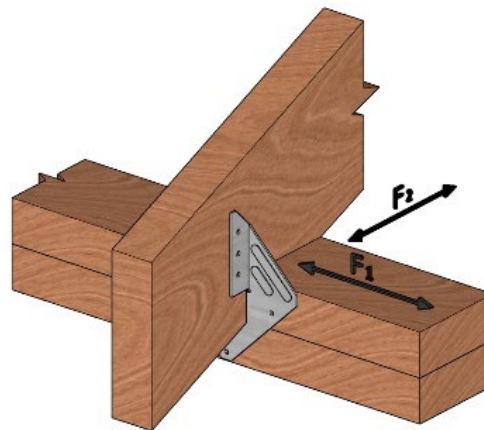

**Figure 4**

2. If wall sheathing is used to transfer loads from top plate in wood frame walls to studs, metal straps connecting the trusses/rafters to the top plate of the wall must be on the same side as the sheathing or additional metal connectors are required to transfer loads from the wall top plate to the wall studs and they must be located on the same side of the top plate as the metal straps connecting the trusses or rafters to the top plate.

**4. Interior Shear Walls**

1. Interior shear wall stud member spacing shall not exceed 16 in. O.C.
2. Interior shear walls must be fully sheathed with  $7/16$  in. minimum wood structural panels attached with 8d common nails at a maximum of 4 in O.C. along edges and 12 in. O.C. in the field of the panels and shall be permitted for floor and/or ceiling joists on slab-on-grade concrete footing size per Table F4.



## 5. Exterior Wall Construction

1. Wall stud member spacing shall not exceed 16 in. O.C.
2. Wood frame exterior walls must be fully sheathed on the exterior face including areas above or below wall openings with minimum  $\frac{7}{16}$ -in. wood structural panels. Exterior wall sheathing shall be attached to the wall framing using the following:
  1. For one-story building or top story of two-story building, wood structural panels shall be fastened to the wall studs with 8d common nails, 10d box nails or 8d ring-shank nails at a maximum of 4 in. O.C. along all edges and 12 in. O.C. to framing members in the field of the panels.
  2. For bottom story of two-story building, wood structural panels shall be fastened to the wall studs with 8d common nails, 10d box nails or 8d ring-shank nails at a maximum of 3 in. O.C. along all edges and 12 in. O.C. to framing members in the field of the panels.
3. Wood frame exterior walls must be fully sheathed on the interior face including areas above or below wall openings with minimum  $\frac{1}{2}$ -in. gypsum wallboard attached with 5d cooler nails at a maximum of 7 in. O.C. along edges and 12 in. O.C. in the field of the panels.

## 6. Floor-to-Floor Connections (for 2-story structures)

1. For 2-story wood frame buildings to transfer vertical loads, install metal straps that connect wall studs from the wall above to wall studs in the wall below or from wall studs above to the rim board and from the rim board to the wall studs below to achieve the uplift capacities outlined in Table F3. Straps can be installed on each stud or at some other convenient spacing not to exceed 8 ft. For example, for a 24-ft roof span with straps installed at 4-ft spacing, the required capacity of the strap would be 784 lb (196 lb multiplied by 4-ft spacing).

**Table F3.** Floor-to-Floor Connection Loads per Ft of Wall Length Based on Roof Span

Roof Span (ft)	20	24	28	32	36
Strap Capacity (lb/ft of wall length)	164	196	229	261	296

**Note:** Based on wall dead weight of 7 psf and height of 8 ft.

2. For 2-story wood frame buildings to transfer shear loads, use continuous sheathing (minimum 4ft) that spans across the floor depth to connect the upper wall, rim board, and lower wall per fastening schedule specified in 2018 IRC Table R602.3(1). Nail spacing along studs shall not be less than 3 in.
3. Hold-downs connecting upper shear walls to lower shear walls shall each have a capacity of 4,360 lb as per Table F5.

4. Floor sheathing shall be wood structural panels with  $\frac{3}{4}$  in. minimum thickness installed over floor support members and fastened with 10d common nails at 4 in. O.C. to perimeter rim joists and edges and at 12 in. O.C. in the field.
5. Exterior wall framing connection to floor diaphragm (top plate of lower wall and bottom plate of upper wall) shall be adequate to resist a shear load of 308 lb per linear foot.

## 7. Opening Framing Connections

1. Strapping is required at ends of openings in wood frame exterior walls when openings are greater than 3 ft and less than 6 ft wide:
  1. Strap double top plate to king stud using strapping with 1,295 lb capacity at each end of opening.
  2. Header to be connected directly to double-top plates or by infill studs to top plate for 353 plf by straps, clips, ties, or metal connectors, etc.
  3. Strap end of header to jack stud using strapping with 1,060 lb uplift capacity at each end of header.
  4. Connect king/jack stud-pack to support wall below or foundation using strapping with capacity of 1,295 lb at each end of opening.

## 8. Footings & Wall Anchorage

1. Anchor floor system and exterior walls to foundation using  $\frac{5}{8}$ -in.-diameter anchor bolts with 8 in. embedment into concrete and a 3-in. x 3-in. x  $\frac{1}{4}$ -in.-thick plate washer at 24 in. O.C. maximum and 6 in. from end of bottom plate.
2. Slab on grade reinforced concrete footing shall conform with Table F4 minimum requirements:

**Table F4.** Concrete Footing Size and Reinforcement

	1-Story	2-Story
Footing Size (Width x Depth)	20 in. W x 16 in. D	21 in. W x 12 in. D
Min. Reinforcement	(3) #5 continuous	(3) #5 continuous

**Note:** Footing sizes are based on 36 ft roof span uplift resistance and 2018 IRC Table R403.1 minimum width and thickness for concrete footing.

3. Hold-downs connecting exterior walls at corners and interior shear walls at ends to foundation shall be installed. The capacity of the hold-down shall be 4,360 lb for each story level as per Table F5.

**Table F5.** Required Capacities for Shear Wall Hold-Downs

Location	1-Story	2-Story
Upper wall to lower wall	N/A	4,360 lb
Wall to foundation	4,360 lb	8,720 lb

## 9. Floor Joist Blocking

- Blocking shall be installed at floor deck edges in the first 2 joist or truss bays from exterior walls for edges where walls are parallel to floor joists or floor trusses. Blocking shall be spaced a maximum of 4 ft O.C. and connected using three (3) 16d nails at each end and two (2) 16d nails through the floor sheathing above. For a second-floor-level floor system, a strap with a minimum capacity of 200 lb shall be installed so that it wraps the outside edge of the double top plate of the wall below and is connected to the bottom of the blocking in the first bay.

## 10. Gable End Bracing

- Gable end bracing is required for systems not using balloon framing or walls with continuous reinforcing to the roof deck level. Install continuous 2-in. x 4-in. lateral brace at ceiling from gable end truss to opposite end of attic at 6 ft O.C. Each lateral brace to have a minimum 20-gauge metal strap connected to the lateral brace that also wraps over bottom chord of gable end wall plate/truss, over the top plate of wall below and is connected to stud in wall below. Strap to be fastened with ten (10) 8d nails at each end of strap for wood frame wall below. Blocking (2-in. x 4-in.) must be added in bay between gable wall framing and first ceiling joist or truss and attached to bottom of lateral brace with four (4) 10d nails. Refer to Fig. 3.7a in 2018 WFCM.

## Appendix G. FORTIFIED CLP Guidance for Retrofit of Existing Homes

A professional engineer (refer to [Appendix D](#) for definition) must perform site inspections(s) to identify structural components that need retrofitting to meet the requirements of current building code, minimum structural safety requirements, and FORTIFIED Roof, FORTIFIED Silver and FORTIFIED Gold requirements. The following CLP elements at minimum are to be inspected and, if found inadequate, retrofitted to bring them to a status meeting the conditions described below.

**NOTE:** *If it is determined that retrofitting is required, the engineer must provide retrofit designs including connections to resist wind pressures and resulting loads using  $V_{ult} = 130$  mph for terrain Exposure C.*

### I. Roof Construction and Framing

- Roof framing member can be either wood trusses or rafters:
  - i. Wood engineered trusses framing:
    - Truss framing does not exceed 24 in. O.C.
    - Existing truss members appear to be in sound condition and supporting appropriate roof loads:
      - a) Wood members of any truss are not deteriorated or damaged.
      - b) All truss connector plates at each joint of any truss member are in good condition.
    - Alteration and/or repair of any truss members has been fully investigated and certified by a design professional to ensure such member(s) can safely carry the appropriate gravity and uplift loads.
  - ii. Roof rafter and ceiling joist framing:
    - Roof rafter and ceiling joist member size, spacing, span, and framing shall comply with, at a minimum, IRC requirements for the appropriate lumber species and grade. Roof rafter framing shall conform to one of the following two construction methods listed in the IRC:
      - **Method 1:** Braced rafter construction
      - **Method 2:** Collar ties or ridge straps construction
        - a) Roof rafter collar ties or ridge straps to resist wind uplift shall be connected in the upper third of the attic space in accordance with IRC requirements.
    - When ceiling joists or rafter ties are not provided for a section of or an entire roof rafter framing area, the ridge formed by these rafters shall be supported by a wall or girder designed in accordance with accepted engineering practice. The gravity and uplift loads carried by these walls or girders shall be safely transmitted down to the foundation support.
- Roof sheathing thickness and material are appropriate for the span between truss framing members to carry required loads but is not less than  $7/16$  in. OSB/plywood.
- Roof sheathing is fastened to all roof framing members and along all perimeters with fastener size and spacing to sufficiently resist appropriate wind uplift pressures and horizontal shear diaphragm forces.
- Roof framing member bearing at each support wall, beam, or column shall have a sufficient connection to resist the appropriate gravity and wind uplift forces.

- Roof framing member bearing at top of all exterior bearing walls shall have sufficient capacity to provide lateral support to brace the wall from both positive and negative wind pressures.
- Each roof framing member to another roof framing member intersection shall have a connection with sufficient capacity to resist both the appropriate gravity and wind uplift forces.
- Support girders or beams shall be capable of accommodating all loads imposed.
- Each bearing support of the girder or beam shall have a connection with sufficient capacity to resist the appropriate gravity and wind uplift forces.

## II. Wall Construction and Framing

- Wall framing system\* shall be capable of accommodating all external loads imposed at each level of building:

\* Wall framing system can be either shear wall, moment-resisting frame, or combination.

### i. Basement walls or below grade portion of any walls

- Wall framing shall resist lateral earth pressure due to “saturated” soil condition and/or lateral wind pressures on partially exposed wall portion.
- Wall framing shall have capacity to simultaneously carry gravity loads from above and resist stated lateral pressures.
- Top and bottom of the wall framing shall be mechanically fastened to structural framing members to resist lateral force due to above stated forces. For example: bottom of wall shall be fastened to the foundation and top of wall shall be fastened to a floor framing system with sufficient horizontal diaphragm capacity.
- Portion of walls in contact with soil shall be protected by water-resistant materials.

### ii. Exterior bearing walls

- Wall framing system must resist all imposed loads (wind, gravity) and be capable of transmitting the resulting loads to the foundation.
  - Forces acting perpendicular to wall surface (wind pressure acting perpendicular to wall height)
  - Forces acting parallel to length of wall segment (base shear or shear diaphragm)
- Wall framing system shall be capable of supporting gravity loads from each floor framing system above plus the roof framing system and applicable lateral loads.
- Structural framing around wall opening shall be sufficient to carry above stated loads. Example: column on each side of opening, beam spanning over the opening, and the connection of beam to column at each side shall be sufficient to accommodate gravity, uplift, and applicable lateral loads.
- Top and bottom of the wall framing system shall be mechanically fastened to structural framing members to resist lateral wind pressures and uplift forces.
- Bottom of the wall framing system shall be mechanically fastened to the support structural member/system below to resist base shear forces resulting from summation of shear wall or moment-resisting system loads of all floor level(s) above plus the its current floor level.
- Wall framing system at each level shall provide sufficient lateral stability for the overall structure resulting from all applicable lateral loads.

iii. Interior bearing walls

- Interior bearing wall framing system shall resist all applicable loads imposed.
- Top of wall framing system shall provide sufficient bearing surface for roof or floor framing members and shall be connected to each supported framing members to resist applicable uplift and lateral forces.
- Bottom of wall framing system shall be properly supported by a structural framing system such as foundation, floor framing, or bearing wall. Bottom of wall framing system shall be connected to support systems below to transmit applicable gravity, uplift, and lateral forces to support system below.

**III. Floor Construction and Framing**

- The floor framing system must support all applicable IRC live loads, all imposed dead loads, plus any interior bearing walls or columns resting on it.
- Floor framing systems shall resist horizontal shear diaphragm resulting from applicable lateral forces.
- Floor framing system shall be properly supported and sufficiently connected to safely transmit all applicable gravity, uplift, and lateral forces to structural support system below.

**IV. Continuous Load Path Verification**

A continuous and adequate load path from the roof to the foundation of the home must exist. The building must have positive connection from the roof to foundation as a means to transmit wind uplift and lateral shear loads safely to the ground. This includes providing roof-to-wall connection hardware with required uplift and shear resistance as determined by the professional designer.

- Roof-to-wall connections shall resist uplift and applicable shear forces.
- Wall above-to-below shall have sufficient connection to resist cumulative uplift and shear forces.
- Ground wall-to-foundation connection must resist cumulative uplift and shear forces.

**V. Foundation Support System Verification**

- Existing foundation support system must resist gravity loads, uplift, and lateral shear forces to provide building stability.
- Complete Continuous load path verification and/or retrofit design shall be documented on the GC3 Gold Compliance Form for Engineer – CLP for Retrofit of Existing Home and signed by the professional engineer responsible for the verification and/or design.
- Installation of the continuous load path elements shall be documented on the GC4 Gold Compliance Form for Contractor – CLP for Retrofit of Existing Home and signed by the contractor responsible for installation.